

Features

Printed circuit mount, general purpose
 2, 3 & 4 Pole relays
 55.12 - 2 Pole 10 A
 55.13 - 3 Pole 10 A
 55.14 - 4 Pole 7 A

- AC coils & DC coils
- Cadmium Free contacts (preferred version)
- Contact material options
- RT III (wash tight) option available

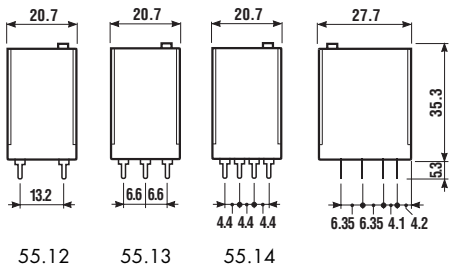

55.12 55.13 55.14

55.12



- 2 pole 10 A
- PCB mount

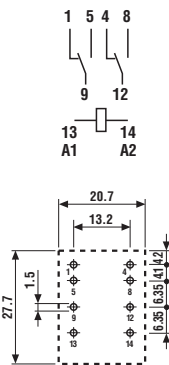

Copper side view

55.13



- 3 pole 10 A
- PCB mount

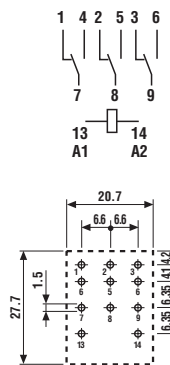

Copper side view

55.14



- 4 pole 7 A
- PCB mount

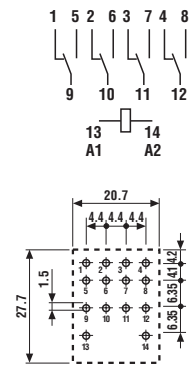

Copper side view

Contact specification

| | | | |
|--|--------------|--------------|-------------|
| Contact configuration | 2 CO (DPDT) | 3 CO (3PDT) | 4 CO (4PDT) |
| Rated current/Maximum peak current A | 10/20 | 10/20 | 7/15 |
| Rated voltage/Maximum switching voltage V AC | 250/400 | 250/400 | 250/250 |
| Rated load AC1 VA | 2,500 | 2,500 | 1,750 |
| Rated load AC15 (230 V AC) VA | 500 | 500 | 350 |
| Single phase motor rating (230 V AC) kW | 0.37 | 0.37 | 0.125 |
| Breaking capacity DC1: 30/110/220 VA | 10/0.25/0.12 | 10/0.25/0.12 | 7/0.25/0.12 |
| Minimum switching load mW (V/mA) | 300 (5/5) | 300 (5/5) | 300 (5/5) |
| Standard contact material | AgNi | AgNi | AgNi |

Coil specification

| | | | | |
|-------------------------------------|--|---|--|---------------------------|
| Nominal voltage (U _N) | V AC (50/60 Hz) | 6 - 12 - 24 - 48 - 60 - 110 - 120 - 230 - 240 | | |
| | V DC | 6 - 12 - 24 - 48 - 60 - 110 - 125 - 220 | | |
| Rated power AC/DC VA (50 Hz)/W | 1.5/1 | 1.5/1 | 1.5/1 | |
| Operating range | AC | (0.8...1.1)U _N | (0.8...1.1)U _N | (0.8...1.1)U _N |
| | DC | (0.8...1.1)U _N | (0.8...1.1)U _N | (0.8...1.1)U _N |
| Holding voltage AC/DC | 0.8 U _N /0.5 U _N | 0.8 U _N /0.5 U _N | 0.8 U _N /0.5 U _N | |
| Must drop-out voltage AC/DC | 0.2 U _N /0.1 U _N | 0.2 U _N /0.1 U _N | 0.2 U _N /0.1 U _N | |

Technical data

| | | | |
|--|--|--|--|
| Mechanical life AC/DC cycles | 20 · 10 ⁶ /50 · 10 ⁶ | 20 · 10 ⁶ /50 · 10 ⁶ | 20 · 10 ⁶ /50 · 10 ⁶ |
| Electrical life at rated load AC1 cycles | 200 · 10 ³ | 200 · 10 ³ | 150 · 10 ³ |
| Operate/release time ms | 9/3 | 9/3 | 9/3 |
| Insulation between coil and contacts (1.2/50 μs) kV | 3.6 | 3.6 | 3.6 |
| Dielectric strength between open contacts V AC | 1,000 | 1,000 | 1,000 |
| Ambient temperature range °C | -40...+85 | -40...+85 | -40...+85 |
| Environmental protection | RT I | RT I | RT I |

Approvals (according to type)



Features

Plug-in mount, general purpose

2, 3 & 4 Pole relays

55.32 - 2 Pole 10 A

55.33 - 3 Pole 10 A

55.34 - 4 Pole 7 A

- Lockable test button and mechanical flag indicator as standard on 2 & 4 pole types
- AC coils & DC coils
- UL Listed (certain relay/socket combinations)
- Cadmium Free contacts (preferred version)
- Contact material options
- Rear flange mount option
- 94 series sockets, coil suppression and timer accessories

55

55.32



- 2 pole 10 A
- Plug-in 94 series sockets

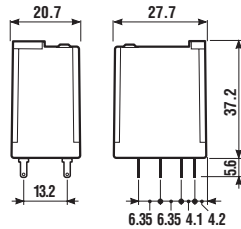
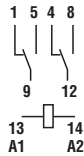

55.33



- 3 pole 10 A
- Plug-in 94 series sockets

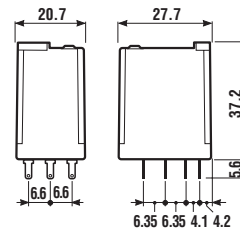
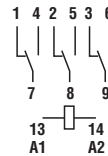

55.34



- 4 pole 7 A
- Plug-in 94 series sockets

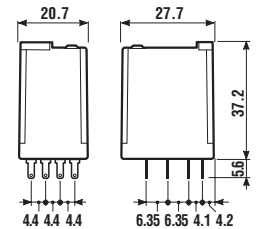
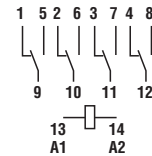

| Contact specification | | | | | |
|--|-----------------|--|---|--|--|
| Contact configuration | | | 2 CO (DPDT) | 3 CO (3PDT) | 4 CO (4PDT) |
| Rated current/Maximum peak current | A | | 10/20 | 10/20 | 7/15 |
| Rated voltage/Maximum switching voltage | V AC | | 250/400 | 250/400 | 250/250 |
| Rated load AC1 | VA | | 2,500 | 2,500 | 1,750 |
| Rated load AC15 (230 V AC) | VA | | 500 | 500 | 350 |
| Single phase motor rating (230 V AC) | kW | | 0.37 | 0.37 | 0.125 |
| Breaking capacity DC1: 30/110/220 V | A | | 10/0.25/0.12 | 10/0.25/0.12 | 7/0.25/0.12 |
| Minimum switching load | mW (V/mA) | | 300 (5/5) | 300 (5/5) | 300 (5/5) |
| Standard contact material | | | AgNi | AgNi | AgNi |
| Coil specification | | | | | |
| Nominal voltage (U _N) | V AC (50/60 Hz) | | 6 - 12 - 24 - 48 - 60 - 110 - 120 - 230 - 240 | | |
| | V DC | | 6 - 12 - 24 - 48 - 60 - 110 - 125 - 220 | | |
| Rated power AC/DC | VA (50 Hz)/W | | 1.5/1 | 1.5/1 | 1.5/1 |
| Operating range | AC | | (0.8...1.1)U _N | (0.8...1.1)U _N | (0.8...1.1)U _N |
| | DC | | (0.8...1.1)U _N | (0.8...1.1)U _N | (0.8...1.1)U _N |
| Holding voltage | AC/DC | | 0.8 U _N /0.5 U _N | 0.8 U _N /0.5 U _N | 0.8 U _N /0.5 U _N |
| Must drop-out voltage | AC/DC | | 0.2 U _N /0.1 U _N | 0.2 U _N /0.1 U _N | 0.2 U _N /0.1 U _N |
| Technical data | | | | | |
| Mechanical life AC/DC | cycles | | 20 · 10 ⁶ /50 · 10 ⁶ | 20 · 10 ⁶ /50 · 10 ⁶ | 20 · 10 ⁶ /50 · 10 ⁶ |
| Electrical life at rated load AC1 | cycles | | 200 · 10 ³ | 200 · 10 ³ | 150 · 10 ³ |
| Operate/release time | ms | | 9/3 | 9/3 | 9/3 |
| Insulation between coil and contacts (1.2/50 μs) | kV | | 3.6 | 3.6 | 3.6 |
| Dielectric strength between open contacts | V AC | | 1,000 | 1,000 | 1,000 |
| Ambient temperature range | °C | | -40...+85 | -40...+85 | -40...+85 |
| Environmental protection | | | RT I | RT I | RT I |

| | |
|--------------------------------------|--|
| Approvals (according to type) | |
|--------------------------------------|--|

Ordering information

Example: 55 series plug-in relay, 4 CO (4PDT), 12 V DC coil, lockable test button and mechanical indicator.

| | | | | | | | | | | |
|-------------------------|------------|------------|----------|------------|----------------|------------|----------|----------|----------|----------|
| | 5 5 | . 3 | 4 | . 9 | . 0 1 2 | . 0 | 0 | 4 | 0 | |
| | | | | | | | A | B | C | D |
| Series | | | | | | | | | | |
| Type | | | | | | | | | | |
| 1 = PCB | | | | | | | | | | |
| 3 = Plug-in | | | | | | | | | | |
| No. of poles | | | | | | | | | | |
| 2 = 2 pole, 10 A | | | | | | | | | | |
| 3 = 3 pole, 10 A | | | | | | | | | | |
| 4 = 4 pole, 7 A | | | | | | | | | | |
| Coil version | | | | | | | | | | |
| 8 = AC (50/60 Hz) | | | | | | | | | | |
| 9 = DC | | | | | | | | | | |
| Coil voltage | | | | | | | | | | |
| see coil specifications | | | | | | | | | | |

A: Contact material

0 = Standard AgNi

2 = AgCdO

5 = AgNi + Au (5 μm)

B: Contact circuit

0 = CO (nPDT)

D: Special versions

0 = Standard

1 = Wash tight (RT III)
for 55.12, 55.13 and 55.14 only

6 = Rear flange mount

C: Options

0 = None

1 = Lockable test button

2 = Mechanical indicator

3 = LED (AC)

4 = Lockable test button+mechanical indicator

5 = Lockable test button + LED (AC)

54 = Lockable test button + LED (AC)
+ mechanical indicator

6 = Double LED (DC non-polarized)

7 = Lockable test button + double LED
(DC non-polarized)

74 = Lockable test button + double LED
(DC non-polarized)
+ mechanical indicator

8 = LED + diode
(DC, polarity positive to pin A1/13)

9 = Lockable test button + LED + diode (DC,
polarity positive to pin A1/13)

94 = Lockable test button + LED + diode (DC,
polarity positive to pin A1/13)
+ mechanical indicator

Selecting features and options: only combinations in the same row are possible.
Preferred selections for best availability are shown in **bold**.

| Type | Coil version | A | B | C | D |
|-------------|--------------|------------------|----------|------------------------------|--------------|
| 55.32/34 | AC-DC | 0 - 2 - 5 | 0 | 0 | 0 - 6 |
| | AC | 0 - 2 - 5 | 0 | 2 - 3 - 4 - 5 | 0 - 6 |
| | AC | 0 - 2 - 5 | 0 | 54 | / |
| | DC | 0 - 2 - 5 | 0 | 2 - 4 - 6 - 7 - 8 - 9 | 0 - 6 |
| | DC | 0 - 2 - 5 | 0 | 74 - 94 | / |
| 55.33 | AC-DC | 0 - 2 - 5 | 0 | 0 | 0 - 6 |
| | AC | 0 - 2 - 5 | 0 | 1 - 3 - 5 | 0 - 6 |
| | DC | 0 - 2 - 5 | 0 | 1 - 6 - 7 - 8 - 9 | 0 - 6 |
| 55.12/13/14 | AC-DC | 0 - 2 - 5 | 0 | 0 | 0 - 1 |

Descriptions: Options and Special versions

| | | | |
|---|--|---|---|
| | | | |
| <p>C: Option 3, 5, 54 LED (AC)</p> | <p>C: Option 6, 7, 74 Double LED (DC non-polarized)</p> | <p>C: Option 8, 9, 94 LED + diode (DC, polarity positive to pin A1/13)</p> | <p>D: Special versions 6 Rear flange mount</p> |



Lockable test button and mechanical flag indicator (0040)

The dual-purpose Finder test button can be used in two ways:

Case 1) The plastic pip (located directly above the test button) remains intact. In this case, when the test button is pushed, the contacts operate. When the test button is released the contacts return to their former state.

Case 2) The plastic pip is broken-off (using an appropriate cutting tool). In this case, (in addition to the above function), when the test button is pushed and rotated, the contacts are latched in the operating state, and remain so until the test button is rotated back to its former position. In both cases ensure that the test button actuation is swift and decisive.

Technical data

Insulation

| | | | | |
|---|---------------------------------|------|----------------|-----------------------------|
| Insulation according to EN 61810-1 ed. 2 | insulation rated voltage | V | 400 (2-3 pole) | 250 (4 pole) |
| | rated impulse withstand voltage | kV | 3.6 (2-3 pole) | 2.5 (4 pole) |
| | pollution degree | | 2 | |
| | overvoltage category | | III | |
| Insulation between coil and contacts (1.2/50 μ s) | | kV | 3.6 | |
| Dielectric strength between open contacts | | V AC | 1,000 | |
| Dielectric strength between adjacent contact | | V AC | 2,000 (2 CO) | 2,000 (3 CO) 1,550 (4 CO) |

Conducted disturbance immunity

| | | |
|---|--------------|----------------|
| Burst (5...50)ns, 5 kHz, on A1 - A2 | EN 61000-4-4 | level 4 (4 kV) |
| Surge (1.2/50 μ s) on A1 - A2 (differential mode) | EN 61000-4-5 | level 4 (4 kV) |

Other data

| | | | | |
|---|-------------------------|----------|------------|-------------------------|
| Bounce time: NO/NC | ms | 1/4 | | |
| Vibration resistance (5...55)Hz, max. \pm 1 mm: NO/NC | g/g | 15/15 | | |
| Shock resistance | g | 16 | | |
| Power lost to the environment | without contact current | W | 1 (2 pole) | 1 (3 pole) 1 (4 pole) |
| | with rated current | W | 3 (2 pole) | 4 (3 pole) 3 (4 pole) |
| Recommended distance between relays mounted on PCB | mm | \geq 5 | | |

55

Contact specification

F 55 - Electrical life (AC) v contact current

2 and 3 pole relays

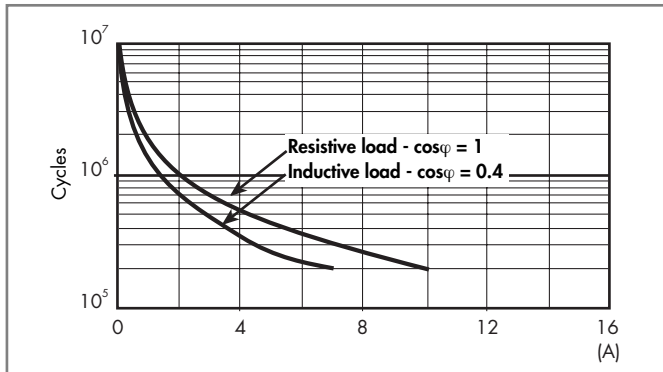

F 55 - Electrical life (AC) v contact current

4 pole relay

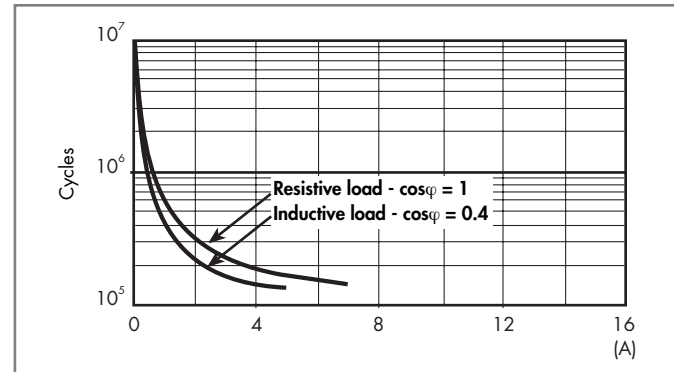

H 55 - Maximum DC1 breaking capacity

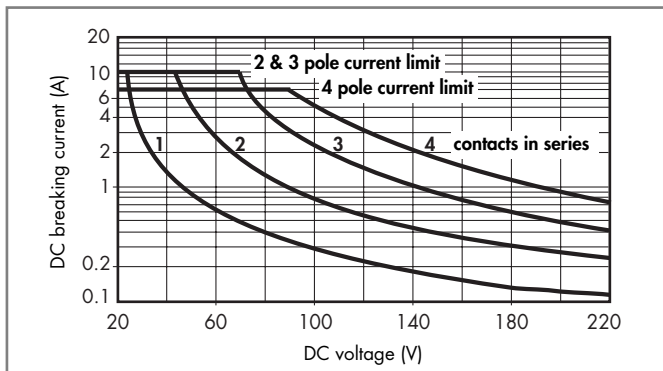

- When switching a resistive load (DC1) having voltage and current values under the curve, an electrical life of $\geq 100 \cdot 10^3$ can be expected.
- In the case of DC13 loads, the connection of a diode in parallel with the load will permit a similar electrical life as for a DC1 load. Note: the release time for the load will be increased.

Coil specifications

DC coil data

| Nominal voltage U_N V | Coil code | Operating range | | Resistance R Ω | Rated coil consumption I at U_N mA |
|-------------------------------|-----------|-----------------|----------------|-----------------------------|--|
| | | U_{min} V | U_{max} V | | |
| 6 | 9.006 | 4.8 | 6.6 | 40 | 150 |
| 12 | 9.012 | 9.6 | 13.2 | 140 | 86 |
| 24 | 9.024 | 19.2 | 26.4 | 600 | 40 |
| 48 | 9.048 | 38.4 | 52.8 | 2,400 | 20 |
| 60 | 9.060 | 48 | 66 | 4,000 | 15 |
| 110 | 9.110 | 88 | 121 | 12,500 | 8.8 |
| 125 | 9.125 | 100 | 137.5 | 17,300 | 7.2 |
| 220 | 9.220 | 176 | 242 | 54,000 | 4 |

AC coil data

| Nominal voltage U_N V | Coil code | Operating range | | Resistance R Ω | Rated coil consumption I at U_N (50Hz) mA |
|-------------------------------|-----------|-----------------|----------------|-----------------------------|---|
| | | U_{min} V | U_{max} V | | |
| 6 | 8.006 | 4.8 | 6.6 | 12 | 200 |
| 12 | 8.012 | 9.6 | 13.2 | 50 | 97 |
| 24 | 8.024 | 19.2 | 26.4 | 190 | 53 |
| 48 | 8.048 | 38.4 | 52.8 | 770 | 25 |
| 60 | 8.060 | 48 | 66 | 1,200 | 21 |
| 110 | 8.110 | 88 | 121 | 4,000 | 12.5 |
| 120 | 8.120 | 96 | 132 | 4,700 | 12 |
| 230 | 8.230 | 184 | 253 | 17,000 | 6 |
| 240 | 8.240 | 192 | 264 | 19,100 | 5.3 |

55

R 55 - DC coil operating range v ambient temperature

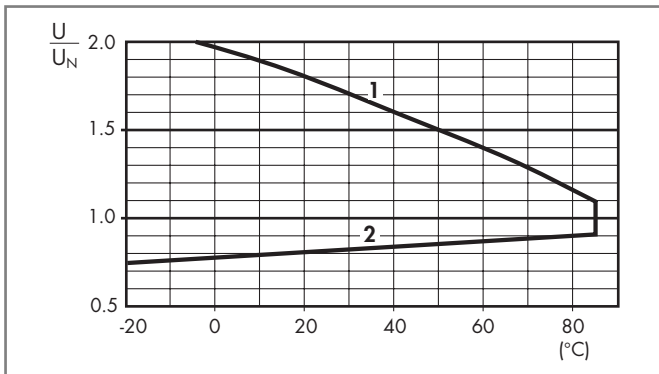

- 1 - Max. permitted coil voltage.
- 2 - Min. pick-up voltage with coil at ambient temperature.

R 55 - AC coil operating range v ambient temperature

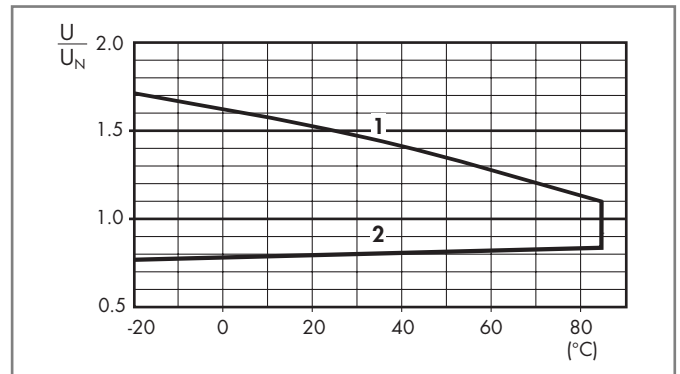

- 1 - Max. permitted coil voltage.
- 2 - Min. pick-up voltage with coil at ambient temperature.

Accessories



055.05



055.05 with relays

Adaptor with top mount flange for 55.32, 55.33, 55.34

055.05

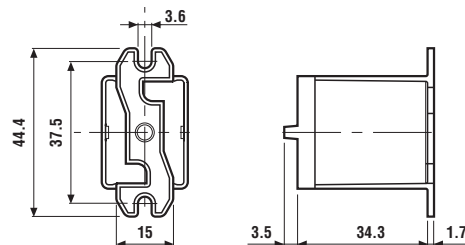



94.04

See page 69



94.54.1

See page 70

55



94.74

See page 71



94.82

See page 71



94.84.3

See page 72



94.94.3

See page 72



94.14

See page 73



94.22

See page 74



94.34

See page 74

| Module | Socket | Relay | Description | Mounting | Accessories |
|--------|--------|----------------|--|--------------------------------------|---|
| 99.02 | 94.02 | 55.32 | Screw terminal (Box clamp) socket | Panel or 35 mm rail (EN 50022) mount | <ul style="list-style-type: none"> - Coil indication and EMC suppression modules - Jumper link - Timer modules - Plastic retaining and release clip |
| | 94.03 | 55.33 | Top terminals - Contacts | | |
| | 94.04 | 55.32 55.34 | Bottom terminals - Coil | | |

| Module | Socket | Relay | Description | Mounting | Accessories |
|--------|---------|----------------|--|-----------------------------|---|
| 99.80 | 94.54.1 | 55.32 55.34 | Screwless terminal socket for fast cable connections Top terminals - Contacts Bottom terminals - Coil | 35 mm rail (EN 50022) mount | <ul style="list-style-type: none"> - Coil indication and EMC suppression modules - Plastic retaining and release clip |

| Module | Socket | Relay | Description | Mounting | Accessories |
|--------|--------|-------|--|--------------------------------------|---|
| 99.01 | 94.72 | 55.32 | Screw terminal (Plate clamp) socket | Panel or 35 mm rail (EN 50022) mount | <ul style="list-style-type: none"> - Coil indication and EMC suppression modules - Metal retaining clip |
| | 94.73 | 55.33 | | | |
| | 94.74 | 55.34 | | | |

| Module | Socket | Relay | Description | Mounting | Accessories |
|--------|--------|-------|---|--------------------------------------|---|
| 99.01 | 94.82 | 55.32 | Screw terminal (Plate clamp) socket - 23 mm wide for space saving | Panel or 35 mm rail (EN 50022) mount | <ul style="list-style-type: none"> - Coil indication and EMC suppression modules - Metal retaining clip |

| Module | Socket | Relay | Description | Mounting | Accessories | |
|--------|---------|-------|--|--------------------------------------|--|--------------------------|
| 99.80 | 94.82.3 | 55.32 | Screw terminal (Box clamp) socket | Panel or 35 mm rail (EN 50022) mount | <ul style="list-style-type: none"> - Coil indication and EMC suppression modules - Jumper link - Plastic retaining and release clip | |
| | 94.84.3 | 55.32 | | | | Top terminals - Contacts |
| | | 55.34 | | | | Bottom terminals - Coil |

| Module | Socket | Relay | Description | Mounting | Accessories | |
|--------|---------|-------|--|--------------------------------------|--|--------------------------|
| 99.80 | 94.92.3 | 55.32 | Screw terminal (Box clamp) socket | Panel or 35 mm rail (EN 50022) mount | <ul style="list-style-type: none"> - Coil indication and EMC suppression modules - Jumper link - Plastic retaining and release clip | |
| | 94.94.3 | 55.32 | | | | Top terminals - Contacts |
| | | 55.34 | | | | Bottom terminals - Coil |

| Module | Socket | Relay | Description | Mounting | Accessories |
|--------|--------|----------------|--------------------|--------------|--|
| — | 94.12 | 55.32 | PCB sockets | PCB mounting | <ul style="list-style-type: none"> - Metal retaining clip |
| — | 94.13 | 55.33 | | | |
| — | 94.14 | 55.32 55.34 | | | |

| Module | Socket | Relay | Description | Mounting | Accessories |
|--------|--------|----------------|--|---------------------------------|--|
| — | 94.22 | 55.32 | Panel mount with solder connections | Panel mount on 1 mm thick panel | <ul style="list-style-type: none"> - Metal retaining clip |
| — | 94.23 | 55.33 | | | |
| — | 94.24 | 55.32 55.34 | | | |

| Module | Socket | Relay | Description | Mounting | Accessories |
|--------|--------|----------------|--|-----------------|--|
| — | 94.32 | 55.32 | Panel mount with solder connections | M3 screw fixing | <ul style="list-style-type: none"> - Metal retaining clip |
| — | 94.33 | 55.33 | | | |
| — | 94.34 | 55.32 55.34 | | | |



94.04
Approvals
(according to type):



cULUS Listed: certain relay/
socket combinations



094.01



060.72

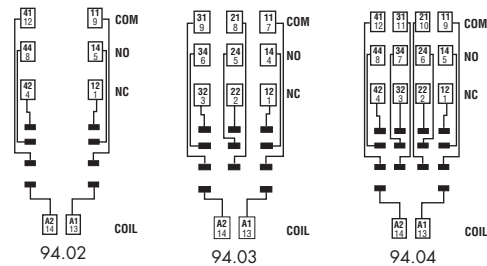

| Screw terminal (Box clamp) socket panel or 35 mm rail mount | 94.02 | 94.02.0 | 94.03 | 94.03.0 | 94.04 | 94.04.0 |
|---|-----------------------------|----------|--------------|---------------|--------------|----------|
| Colour | Blue | Black | Blue | Black | Blue | Black |
| For relay type | 55.32 | | 55.33 | | 55.32, 55.34 | |
| Accessories | | | | | | |
| Metal retaining clip | | | 094.71 | | | |
| Plastic retaining and release clip (supplied with socket - packaging code SPA) | | | 094.01 | | | |
| 6-way jumper link | 094.06 | 094.06.0 | 094.06 | 094.06.0 | 094.06 | 094.06.0 |
| Identification tag | | | 094.00.4 | | | |
| Modules (see table below) | | | 99.02 | | | |
| Timer modules (see table below) | | | 86.10, 86.20 | | | |
| Sheet of marker tags for retaining and release clip 094.01 plastic, 72 tags, 6x12 mm | | | 060.72 | | | |
| Technical data | | | | | | |
| Rated values | 10 A - 250 V | | | | | |
| Dielectric strength | ≥ 2 kV AC | | | | | |
| Protection category | IP 20 | | | | | |
| Ambient temperature | °C -40...+70 | | | | | |
| ⊕ Screw torque | Nm 0.5 | | | | | |
| Wire strip length | mm 8 | | | | | |
| Max. wire size for 94.02/03/04 sockets | solid wire | | | stranded wire | | |
| | mm ² 1x6 / 2x2.5 | | | 1x4 / 2x2.5 | | |
| | AWG 1x10 / 2x14 | | | 1x12 / 2x14 | | |

55

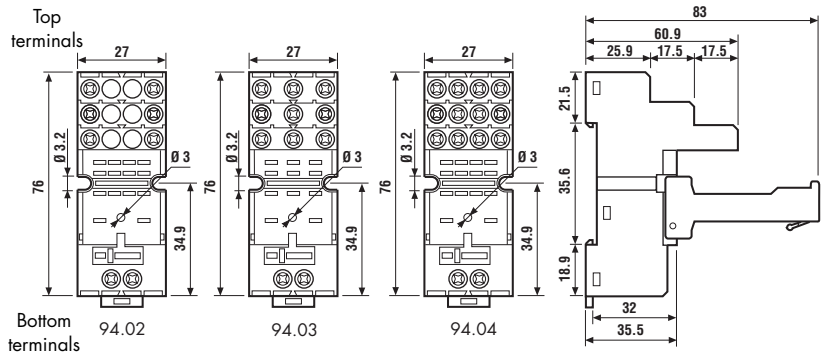

094.06

| | |
|---|--------------|
| 6-way jumper link for 94.02, 94.03 and 94.04 sockets | 094.06 |
| Rated values | 10 A - 250 V |

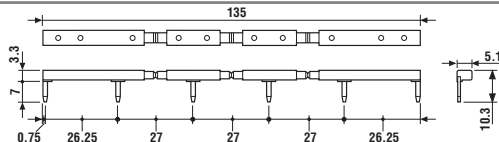

86.10

| | |
|---|------------------|
| 86 series timer modules (see technical data pages 182/186) | Blue |
| Mono-function: (12...24)V AC/DC; function AI; (1.5s...60min) | 86.10.0.024.0000 |
| Mono-function: (12...24)V AC/DC; function DI; (1.5s...60min) | 86.20.0.024.0000 |

Approvals
(according to type):



99.02

Approvals
(according to type):



| 99.02 coil indication and EMC suppression modules for 94.02, 94.03 and 94.04 sockets | | Blue* |
|---|--------------------|----------------|
| See technical data pages 247/248 | | |
| Diode (+A1, standard polarity) | (6...220)V DC | 99.02.3.000.00 |
| LED | (6...24)V DC/AC | 99.02.0.024.59 |
| LED | (28...60)V DC/AC | 99.02.0.060.59 |
| LED | (110...240)V DC/AC | 99.02.0.230.59 |
| LED + Diode (+A1, standard polarity) | (6...24)V DC | 99.02.9.024.99 |
| LED + Diode (+A1, standard polarity) | (28...60)V DC | 99.02.9.060.99 |
| LED + Diode (+A1, standard polarity) | (110...220)V DC | 99.02.9.220.99 |
| LED + Varistor | (6...24)V DC/AC | 99.02.0.024.98 |
| LED + Varistor | (28...60)V DC/AC | 99.02.0.060.98 |
| LED + Varistor | (110...240)V DC/AC | 99.02.0.230.98 |
| RC circuit | (6...24)V DC/AC | 99.02.0.024.09 |
| RC circuit | (28...60)V DC/AC | 99.02.0.060.09 |
| RC circuit | (110...240)V DC/AC | 99.02.0.230.09 |
| Residual current by-pass (62 kΩ/1W) | (110...240)V AC | 99.02.8.230.07 |

* Modules in Black
housing are
available on request.



094.92

94.54.1

Approvals
(according to type):

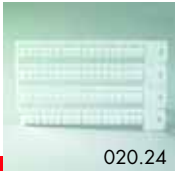

020.24

| Screwless terminal socket 35 mm rail (EN 50022) mount | | 94.54.1 (blue) | 94.54.10 (black) |
|--|-----------------|----------------|------------------|
| For relay type | | 55.32, 55.34 | 55.32, 55.34 |
| Accessories | | | |
| Metal retaining clip | | | 094.71 |
| Plastic retaining and release clip | | | 094.92 |
| Modules (see table below) | | | 99.80 |
| Sheet of marker tags for retaining and release clip 094.92 plastic, 24 tags, 9x17 mm | | | 020.24 |
| Technical data | | | |
| Rated values | | 10 A - 250 V | |
| Dielectric strength | | ≥ 2 kV AC | |
| Protection category | | IP 20 | |
| Ambient temperature | °C | -25...+70 | |
| Wire strip length | mm | 7 | |
| Max. wire size for 94.54.1 socket | | solid wire | stranded wire |
| | mm ² | 2x(0.2...1.5) | 2x(0.2...1.5) |
| | AWG | 2x(24...18) | 2x(24...18) |

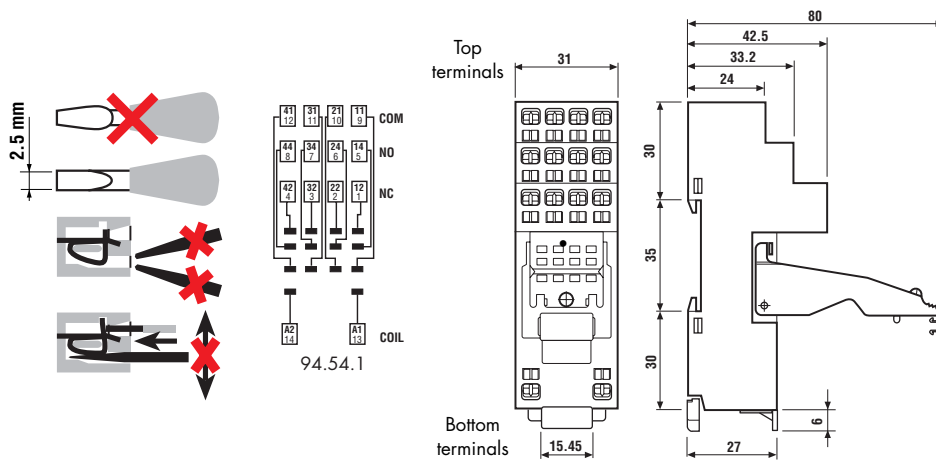

99.80

Approvals
(according to type):



* Modules in Black housing are available on request.

Green LED is standard. Red LED available on request.

| 99.80 coil indication and EMC suppression modules for 94.54.1 socket | | |
|--|--------------------|----------------|
| See technical data pages 247/248 | | Blue* |
| Diode (+A1, standard polarity) | (6...220)V DC | 99.80.3.000.00 |
| LED | (6...24)V DC/AC | 99.80.0.024.59 |
| LED | (28...60)V DC/AC | 99.80.0.060.59 |
| LED | (110...240)V DC/AC | 99.80.0.230.59 |
| LED + Diode (+A1, standard polarity) | (6...24)V DC | 99.80.9.024.99 |
| LED + Diode (+A1, standard polarity) | (28...60)V DC | 99.80.9.060.99 |
| LED + Diode (+A1, standard polarity) | (110...220)V DC | 99.80.9.220.99 |
| LED + Varistor | (6...24)V DC/AC | 99.80.0.024.98 |
| LED + Varistor | (28...60)V DC/AC | 99.80.0.060.98 |
| LED + Varistor | (110...240)V DC/AC | 99.80.0.230.98 |
| RC circuit | (6...24)V DC/AC | 99.80.0.024.09 |
| RC circuit | (28...60)V DC/AC | 99.80.0.060.09 |
| RC circuit | (110...240)V DC/AC | 99.80.0.230.09 |
| Residual current by-pass (62 kΩ/1W) | (110...240)V AC | 99.80.8.230.07 |



Approvals
(according to type):



Approvals
(according to type):



| Screw terminal (Plate clamp) socket panel or 35 mm rail mount | 94.72 | 94.72.0 | 94.73 | 94.73.0 | 94.74 | 94.74.0 |
|---|-------------------------------|--------------|-------------------------------|-----------------|--------------|--------------|
| Colour | Blue | Black | Blue | Black | Blue | Black |
| For relay type | 55.32 | | 55.33 | | 55.32, 55.34 | |
| Accessories | | | | | | |
| Metal retaining clip (supplied with socket - packaging code SMA) | | | 094.71 | | | |
| Modules (see table below) | | | 99.01 | | | |
| Screw terminal (Plate clamp) socket: panel or 35 mm rail mount | 94.82 (blue) | | 94.82.0 (black) | | | |
| For relay type | 55.32 | | 55.32 | | | |
| Accessories | | | | | | |
| Metal retaining clip (supplied with socket - packaging code SMA) | | | 094.71 | | | |
| Modules (see table below) | | | 99.01 | | | |
| Technical data | | | | | | |
| Rated values | 10 A - 250 V | | | | | |
| Dielectric strength | ≥ 2 kV AC | | | | | |
| Protection category | IP 20 | | | | | |
| Ambient temperature | °C -40...+70 | | | | | |
| ⊕ Screw torque | Nm 0.5 | | | | | |
| Wire strip length | mm 8 (94.72/.0/3/.0/4/.0) | | | mm 9 (94.82/.0) | | |
| Max. wire size for 94.72/73/74 and 94.82 sockets | solid wire | | stranded wire | | | |
| | mm ² 1x2.5 / 2x1.5 | | mm ² 1x2.5 / 2x1.5 | | | |
| | AWG 1x14 / 2x16 | | AWG 1x14 / 2x16 | | | |

55

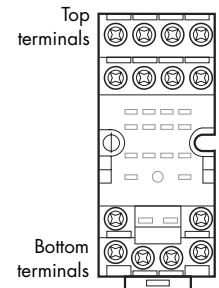
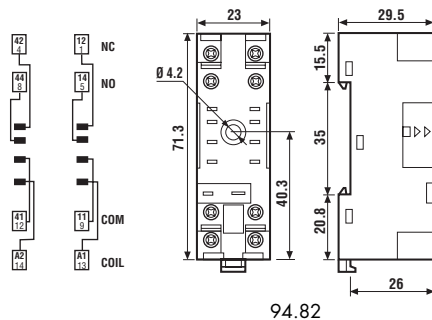
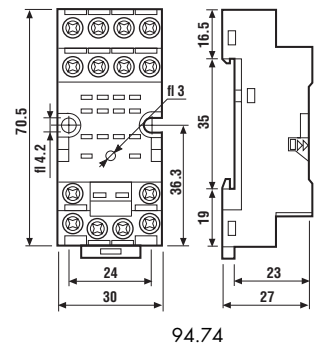
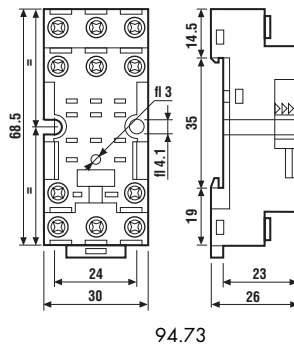
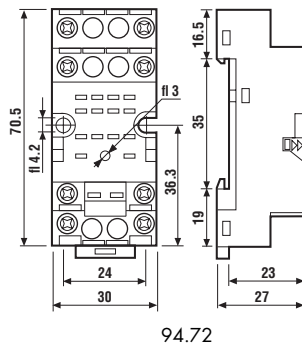
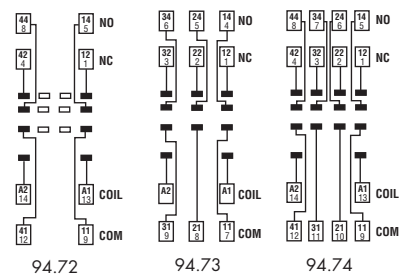

Approvals
(according to type):



* Modules in Black housing are available on request.

Green LED is standard. Red LED available on request.

| 99.01 coil indication and EMC suppression modules for 94.72, 94.73, 94.74 and 94.82 sockets | | Blue* |
|---|--------------------|----------------|
| See technical data pages 247/248 | | |
| Diode (+A1, standard polarity) | (6...220)V DC | 99.01.3.000.00 |
| Diode (+A2, non standard polarity) | (6...220)V DC | 99.01.2.000.00 |
| LED | (6...24)V DC/AC | 99.01.0.024.59 |
| LED | (28...60)V DC/AC | 99.01.0.060.59 |
| LED | (110...240)V DC/AC | 99.01.0.230.59 |
| LED + Diode (+A1, standard polarity) | (6...24)V DC | 99.01.9.024.99 |
| LED + Diode (+A1, standard polarity) | (28...60)V DC | 99.01.9.060.99 |
| LED + Diode (+A1, standard polarity) | (110...220)V DC | 99.01.9.220.99 |
| LED + Diode (+A2, non standard polarity) | (6...24)V DC | 99.01.9.024.79 |
| LED + Diode (+A2, non standard polarity) | (28...60)V DC | 99.01.9.060.79 |
| LED + Diode (+A2, non standard polarity) | (110...220)V DC | 99.01.9.220.79 |
| LED + Varistor | (6...24)V DC/AC | 99.01.0.024.98 |
| LED + Varistor | (28...60)V DC/AC | 99.01.0.060.98 |
| LED + Varistor | (110...240)V DC/AC | 99.01.0.230.98 |
| RC circuit | (6...24)V DC/AC | 99.01.0.024.09 |
| RC circuit | (28...60)V DC/AC | 99.01.0.060.09 |
| RC circuit | (110...240)V DC/AC | 99.01.0.230.09 |
| Residual current by-pass (62 kΩ/1W) | (110...240)V AC | 99.01.8.230.07 |



Approvals
(according to type):



| Screw terminal (Box clamp) socket panel or 35 mm rail mount | 94.82.3 | 94.82.30 | 94.84.3 | 94.84.30 |
|--|-----------------|-------------|---------------|-------------|
| Colour | Blue | Black | Blue | Black |
| For relay type | 55.32 | | 55.32, 55.34 | |
| Accessories | | | | |
| Metal retaining clip (supplied with socket - packaging code SMA) | 094.71 | | | |
| Plastic retaining and release clip | 094.91.3 | | | |
| 6-way jumper link | 094.06 | 094.06.0 | 094.06 | 094.06.0 |
| Identification tag | 094.80.2 | | | |
| Modules (see table next page) | 99.80 | | | |
| Sheet of marker tags for retaining and release clip 094.01 plastic, 72 tags, 6x12 mm | 060.72 | | | |
| Technical data | | | | |
| Rated values | 10 A - 250 V | | | |
| Dielectric strength | ≥ 2 kV AC | | | |
| Protection category | IP 20 | | | |
| Ambient temperature | °C -40...+70 | | | |
| Screw torque | Nm 0.5 | | | |
| Wire strip length | mm 7 | | | |
| Max. wire size for 94.82.3 and 94.84.3 sockets | solid wire | | stranded wire | |
| | mm ² | 1x6 / 2x2.5 | | 1x4 / 2x2.5 |
| | AWG | 1x10 / 2x14 | | 1x12 / 2x14 |

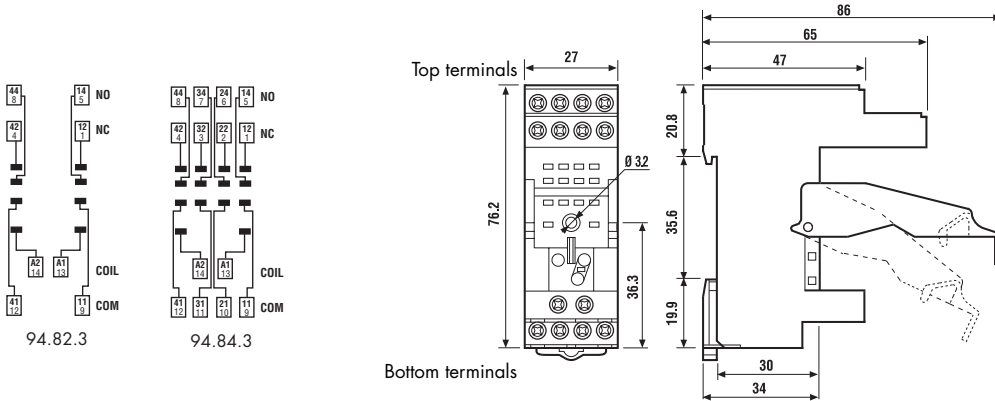

Approvals
(according to type):



| Screw terminal (Box clamp) socket panel or 35 mm rail mount | 94.92.3 (blue) | 94.92.30 (black) | 94.94.3 (blue) | 94.94.30 (black) |
|--|-----------------|------------------|----------------|------------------|
| For relay type | 55.32 | | 55.32, 55.34 | |
| Accessories | | | | |
| Metal retaining clip | 094.71 | | | |
| Plastic retaining and release clip | 094.91.3 | | | |
| 6-way jumper link | 094.06 | 094.06.0 | 094.06 | 094.06.0 |
| Modules (see table next page) | 99.80 | | | |
| Sheet of marker tags for retaining and release clip 094.91.3 plastic, 72 tags, 6x12 mm | 060.72 | | | |
| Technical data | | | | |
| Rated values | 10 A - 250 V | | | |
| Dielectric strength | ≥ 2 kV AC | | | |
| Protection category | IP 20 | | | |
| Ambient temperature | °C -25...+70 | | | |
| Screw torque | Nm 0.5 | | | |
| Wire strip length | mm 8 | | | |
| Max. wire size for 94.92.3 and 94.94.3 sockets | solid wire | | stranded wire | |
| | mm ² | 1x6 / 2x2.5 | | 1x4 / 2x2.5 |
| | AWG | 1x10 / 2x14 | | 1x12 / 2x14 |

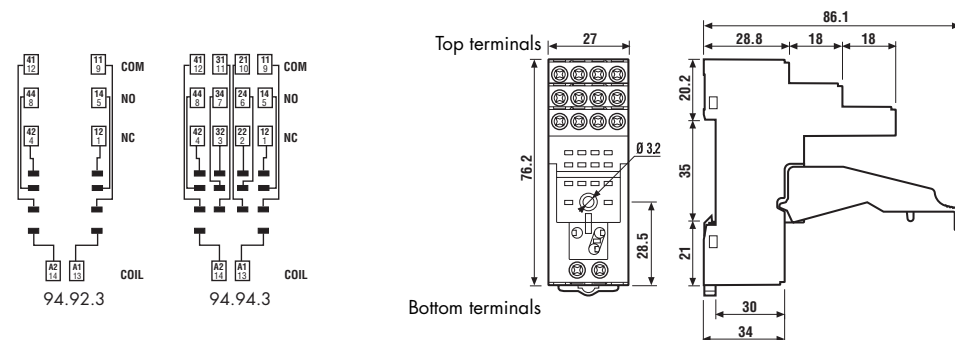



094.06

| | |
|--|--------------|
| 6-way jumper link for 94.82.3 and 94.84.3 sockets | 094.06 |
| Rated values | 10 A - 250 V |

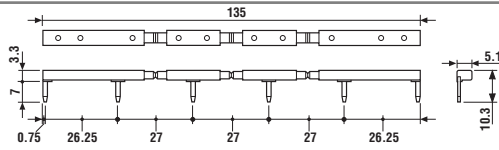

99.80

Approvals
(according to type):



* Modules in Black housing are available on request.

Green LED is standard.
Red LED available on request.

| 99.80 coil indication and EMC suppression modules for 94.82.3, 94.84.3 and 94.92.3, 94.94.3 sockets | | Blue* |
|---|--------------------|----------------|
| See technical data pages 247/248 | | |
| Diode (+A1, standard polarity) | (6...220)V DC | 99.80.3.000.00 |
| LED | (6...24)V DC/AC | 99.80.0.024.59 |
| LED | (28...60)V DC/AC | 99.80.0.060.59 |
| LED | (110...240)V DC/AC | 99.80.0.230.59 |
| LED + Diode (+A1, standard polarity) | (6...24)V DC | 99.80.9.024.99 |
| LED + Diode (+A1, standard polarity) | (28...60)V DC | 99.80.9.060.99 |
| LED + Diode (+A1, standard polarity) | (110...220)V DC | 99.80.9.220.99 |
| LED + Varistor | (6...24)V DC/AC | 99.80.0.024.98 |
| LED + Varistor | (28...60)V DC/AC | 99.80.0.060.98 |
| LED + Varistor | (110...240)V DC/AC | 99.80.0.230.98 |
| RC circuit | (6...24)V DC/AC | 99.80.0.024.09 |
| RC circuit | (28...60)V DC/AC | 99.80.0.060.09 |
| RC circuit | (110...240)V DC/AC | 99.80.0.230.09 |
| Residual current by-pass (62 kΩ/1W) | (110...240)V AC | 99.80.8.230.07 |

55



94.14

Approvals
(according to type):



| PCB socket | 94.12 | 94.12.0 | 94.13 | 94.13.0 | 94.14 | 94.14.0 |
|--|--------------|---------|-------|---------|--------------|---------|
| Colour | Blue | Black | Blue | Black | Blue | Black |
| For relay type | 55.32 | | 55.33 | | 55.32, 55.34 | |
| Accessories | | | | | | |
| Metal retaining clip (supplied with socket - packaging code SMA) | 094.51 | | | | | |
| Technical data | | | | | | |
| Rated values | 10 A - 250 V | | | | | |
| Dielectric strength | ≥ 2 kV AC | | | | | |
| Ambient temperature | °C -40...+70 | | | | | |

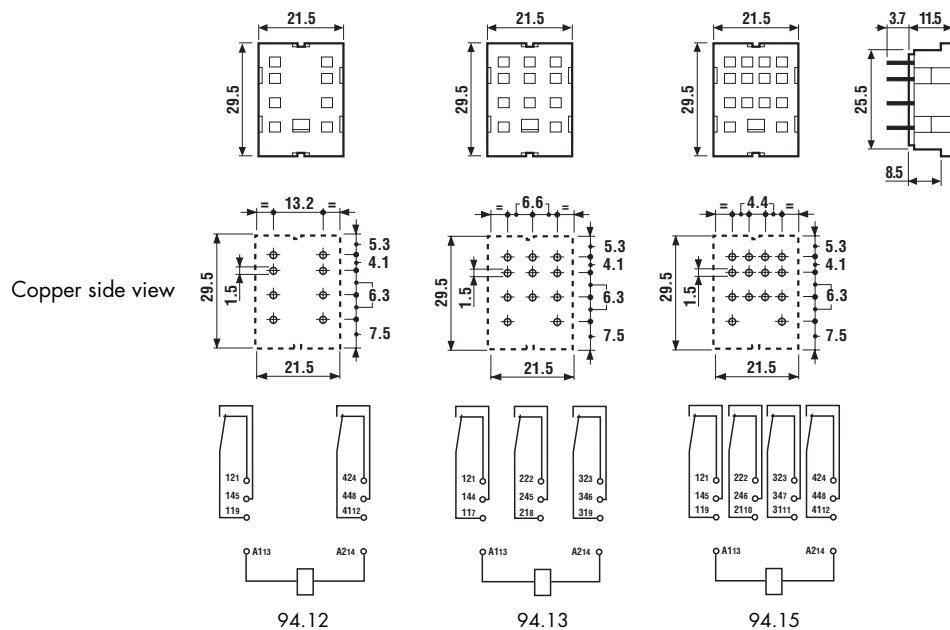



94.22

Approvals
(according to type):



| Panel mount solder socket 1 mm thick panel | 94.22 | 94.22.0 | 94.23 | 94.23.0 | 94.24 | 94.24.0 |
|--|--------------|---------|-------|---------|--------------|---------|
| Colour | Blue | Black | Blue | Black | Blue | Black |
| For relay type | 55.32 | | 55.33 | | 55.32, 55.34 | |
| Accessories | | | | | | |
| Metal retaining clip (supplied with socket - packaging code SMA) | 094.51 | | | | | |
| Technical data | | | | | | |
| Rated values | 10 A - 250 V | | | | | |
| Dielectric strength | ≥ 2 kV AC | | | | | |
| Ambient temperature | °C -40...+70 | | | | | |

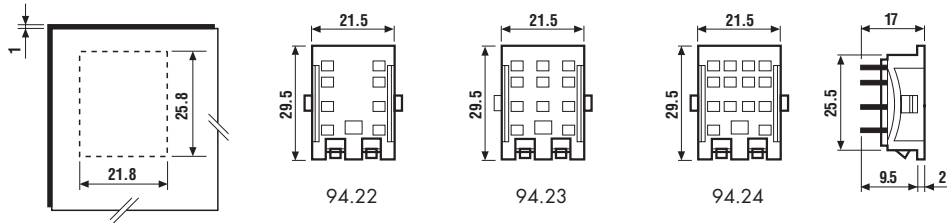

55



94.34

Approvals
(according to type):



| Panel mount socket M3 screw fixing - solder connections | 94.32 | 94.32.0 | 94.33 | 94.33.0 | 94.34 | 94.34.0 |
|--|--------------|---------|-------|---------|--------------|---------|
| Colour | Blue | Black | Blue | Black | Blue | Black |
| For relay type | 55.32 | | 55.33 | | 55.32, 55.34 | |
| Accessories | | | | | | |
| Metal retaining clip (supplied with socket - packaging code SMA) | 094.51 | | | | | |
| Technical data | | | | | | |
| Rated values | 10 A - 250 V | | | | | |
| Dielectric strength | ≥ 2 kV AC | | | | | |
| Ambient temperature | °C -40...+70 | | | | | |

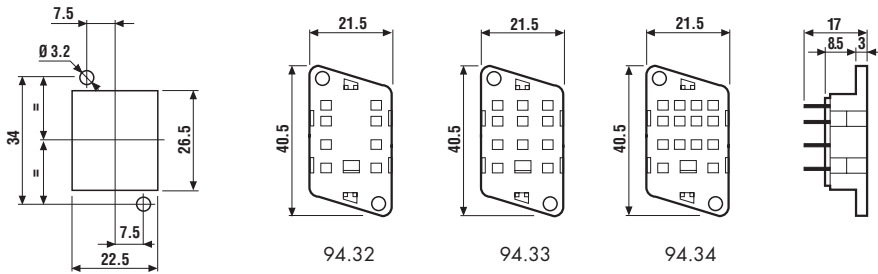

Packaging codes

How to code and identify retaining clip and packaging options for sockets.

Code options according to the last three letters:



A Standard packaging

SM Metal retaining clip
SP Plastic retaining clip



Without retaining clip