

Solid Core and Split Core Adjustable Current “Status” Switches

CSS-O, CSS-C; CSP-O, CSP-C

PRODUCT DATA



FEATURES

- Very low operating trip points
- LED status indication
- Integral DIN rail mounting flange
- Easy wiring, non-polarity sensitive
- Accepts up to a 350 MCM (17.3 mm) cable
- Operates up to 200 or 250 continuous amps
- RoHS and WEEE compliant
- Limited five year warranty

DESCRIPTION

The CSS solid core and the CSP split core current switches have either Normally-Open (N.O.) or Normally-Closed (N.C.) output configurations. All of these sensors will have a solid-state output with an adjustable trip point (setpoint). These current switches are ideal for providing status information on any type of AC current using equipment. The CSS series current switches are an excellent choice for new installations. The CSP series current switches are ideal for retrofit or existing installations since it is not necessary to power down the unit and disconnect any wires during the installation process. The CSS and CSP current switches are accurate, reliable, easy to install and require less servicing than differential pressure switches, flow switches and paddle wheels.

These current switches should be used in applications in which a current switch with adjustable trip point is required. A current switch can be used to monitor fan and pump status, motors, compressors and electrical equipment for proper operation. A change in the operating current may indicate motor failure, belt loss/slippage or mechanical failure. Any time one of these events occur the current can significantly increase or decrease, thus tripping the sensor and notifying building management of an alarm condition.

The CSS and CSP series current switches can be used to monitor devices with a maximum continuous operating current of up to 200 or 250 Amps depending on the model. These switches will not need to be externally powered since the power for the switch is induced from the conductor being monitored. Another great feature of the CSS and CSP series current switches is that they include both a red and green LED that will indicate the “Status” of the switch contacts. All of these units come with a unique 1-3/8 in. (35 mm) DIN rail mounting flange and a limited five year warranty.

Contents

Features	1
Description	1
Specifications	2
Ordering Information	2
Safety	4
Installation	4
Troubleshooting	6



SPECIFICATIONS

Sensor Power: Induced from monitored conductor

Amperage Rating: 0 to 200 Amps and 0 to 250 Amps
(See Table 1)

Operating Frequency Range: 40 Hz to 1 kHz

Isolation Voltage: 2220 Vac

Max Sensing Current Voltage: 600 Vac

Output Switch Rating:

CSS-O; CSP-O: 0.3 Amps @ 200 Vac/Vdc
CSS-C; CSP-C: 0.15 Amps @ 300 Vac/Vdc

Adjustable Trip Point (Setpoint): See Table 1

Hysteresis (Dead Band): 10% Setpoint, typical

Status Indication:

Red LED - Above Trip Point
Green LED - Below Trip Point

Aperture (Hole) Size: 3/4 in. (19 mm), Accepts up to 350 MCM (17.3 mm) cables

Dimensions: See Figures 1 and 2

DIN Rail Size: 1-3/8 in. (35 mm)

Unit Weight:

CSS: 0.21 lb (0.1 kg)
CSP: 0.23 lb (0.1 kg)

Enclosure Rating/Color: UL94-5VB/Burgundy

Operating Temperature Range: 5° to 104° F (-15° to 40° C)

Operating RH Range: 0 to 95% RH, non-condensing

Agency Approvals:

CE, UL

Environmental Compliance:

RoHS-Directive 2002/95/EC

WEEE-Directive 2002/96/EC

NOTE: DO NOT use the LED's to indicate whether the sensors have power applied to them.

Table 1. Operating Specifications

Product Number	Core Type	Normal Position	Adjustable Trip Point	Output Switch Rating	Max. Current Cont.	Max. Current for 6 secs.	Max. Current for 1 sec.
CSS-O-A300-001	Solid	N.O.	1.0-250 Amps	0.30 Amps @ 200 Vac/Vdc	250 Amps	500 Amps	1,000 Amps
CSS-O-A200-001	Solid	N.O.	0.5-250 Amps	0.30 Amps @ 200 Vac/Vdc	250 Amps	500 Amps	1,000 Amps
CSS-C-A300-001	Solid	N.C.	1.0-250 Amps	0.15 Amps @ 300 Vac/Vdc	250 Amps	500 Amps	1,000 Amps
CSP-O-A300-001	Split	N.O.	3.0-200 Amps	0.30 Amps @ 200 Vac/Vdc	200 Amps	400 Amps	800 Amps
CSP-O-A200-001	Split	N.O.	2.0-200 Amps	0.30 Amps @ 200 Vac/Vdc	200 Amps	400 Amps	800 Amps
CSP-C-A300-001	Split	N.C.	3.0-250 Amps	0.15 Amps @ 300 Vac/Vdc	250 Amps	500 Amps	1,000 Amps
CSP-C-A200-001	Split	N.C.	2.5-250 Amps	0.15 Amps @ 300 Vac/Vdc	250 Amps	500 Amps	1,000 Amps

ORDERING INFORMATION

When purchasing replacement and modernization products from your TRADELINE® wholesaler or distributor, refer to the TRADELINE® Catalog or price sheets for complete ordering number.

If you have additional questions, need further information, or would like to comment on our products or services, please write or phone:

1. Your local Honeywell Automation and Control Products Sales Office (check white pages of your phone directory).
2. Honeywell Customer Care
1885 Douglas Drive North
Minneapolis, Minnesota 55422-4386

In Canada—Honeywell Limited/Honeywell Limitée, 35 Dynamic Drive, Toronto, Ontario M1V 4Z9.

International Sales and Service Offices in all principal cities of the world. Manufacturing in Australia, Canada, Finland, France, Germany, Japan, Mexico, Netherlands, Spain, Taiwan, United Kingdom, U.S.A.

SAFETY

⚠ WARNING

For CSS-O,C ensure that all power sources are disconnected and locked out before installation as severe injury or death may result from electrical shock due to contact with high voltage wires.

⚠ CAUTION

This product is not intended to be used for life or safety applications.

⚠ CAUTION

This product is not intended for use in any hazardous or classified locations.

INSTALLATION

Make sure that all installations are in compliance with all national and local electrical codes. Only qualified individuals that are familiar with codes, standards and proper safety procedures for high voltage installations should attempt installation. The current switches will not require external power, since the power for the current switch is induced from the conductor being monitored.

⚠ WARNING

Never rely on the LEDs to determine whether power is present at the current switch. The red LED will indicate whether the current is above the adjustable trip point. The green LED will indicate whether the current is below the adjustable trip point.

IMPORTANT

The current switch should be used on insulated conductors only!

The current switch may be mounted in any position using the (2) #8 x 3/4 in. (19 mm) Tek screws and the mounting holes in the base or snapped directly on to the 1-3/8 in. (35 mm) DIN rail (See Figures 3 and 4). Leave a minimum distance of 1 in. (25 mm) between the current switch and any other magnetic devices, such as contactors and transformers.

For applications in which the normal operating current is below the 0.8/2.0 Amps trip point (See Fig. 5), the conductor being monitored may be looped through the sensor 6/12 times giving you a total operating current of 6/12 times the original current.

Example:

A small fan operating at 0.2 Amps can be wrapped through the sensor 6 times to give you a total operating current of 1.2 Amps flowing through the CSS-O-A300-001. Another option is to use CSS-O-A200-001.

A small fan operating at 0.2 Amps can be wrapped through the sensor 16 times to give you a total operating current of 3.2 Amps flowing through the CSP-O-A300-001. Another option is to use the CSP-O-A200-001.

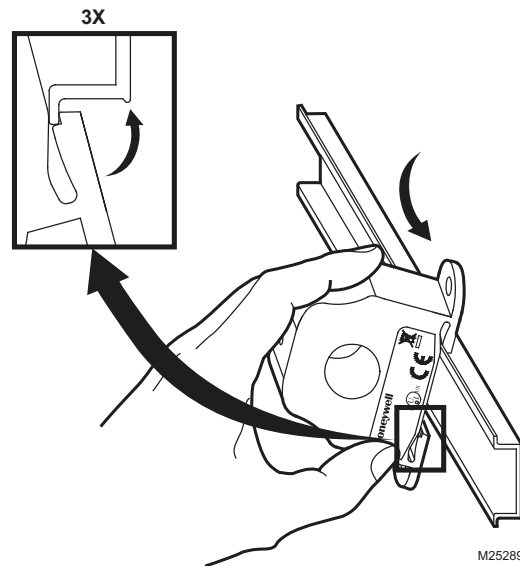

Fig. 3. Sensor placed on DIN rail

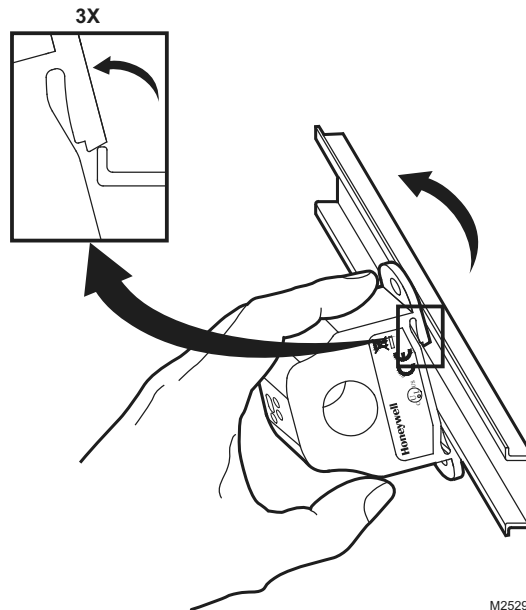

Fig. 4. Sensor removed from DIN rail

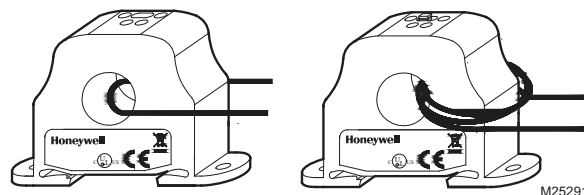
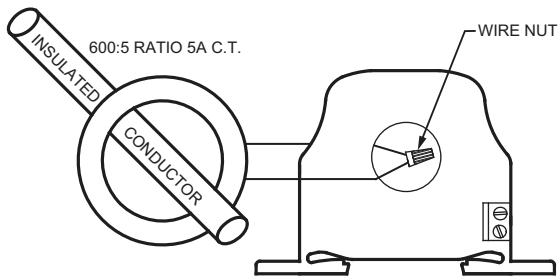

Fig. 5. Wires through sensors

! WARNING

The secondary of the 5 amps current transformer must be shorted together before the power may be turned on to the monitored device.

For applications in which the normal operating current is greater than 250 Amps or for conductor diameters larger than 3/4 in. (19 mm) in diameter, and external 5 Amps Current Transformer (C.T.) must be used as shown in Fig. 6.



EXAMPLE: FOR CURRENTS UP TO 600 AMPS, USE A 600:5 RATIO C.T. AS SHOWN. M25295A

Fig. 6. Current transformer

Latch Operation

Pressing down on the two (2) side tabs and swinging the cover open opens the split core current switch as shown in Fig. 7. Lifting up the latch with a flat-tip screwdriver as shown in Fig. 8 can also open the unit. Press down firmly on the cover to close the current switch. An audible "click" will be heard as the tab slides over the tongue on the base.

! CAUTION

Mating surfaces of the magnetic core are exposed when the sensor is open. Silicone grease, present on the cores to prevent rust, can capture grit and dirt if care is not exercised. Operation can be impaired if anything prevents good contact between pole pieces. Visually check the mating parts of the core before closing the current sensor.

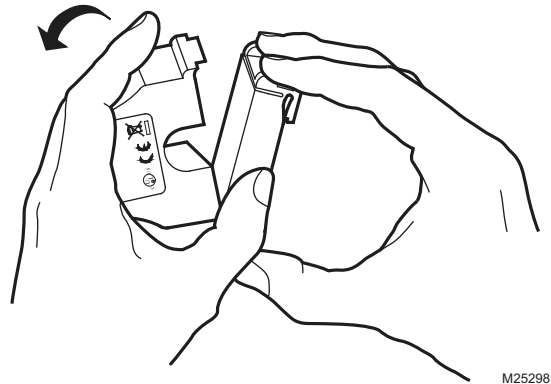
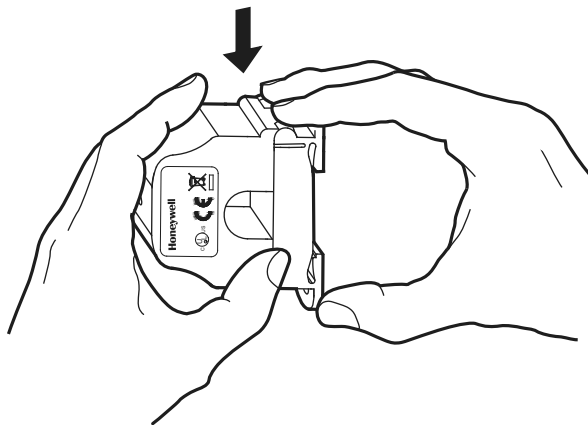

Fig. 7. Opening sensor by hand

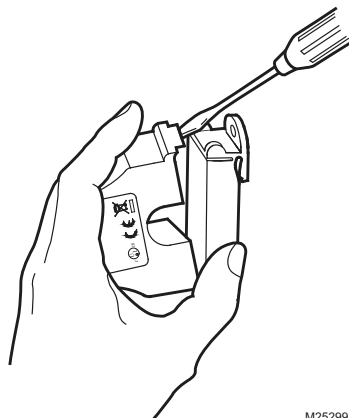

Fig. 8. Opening with a screwdriver

Wiring

Honeywell recommends the use of a 2 conductor 16 to 22 AWG (1.3 to 0.3 mm²) shielded cable or twisted wire, copper wire only, for all current switch output applications. A maximum wire length of less than 98.4 feet (30 meters) should be used between the current switches and the Building Management System or controller.

NOTE: When using a shielded cable, be sure to connect only (1) end of the shield to ground at the controller. Connecting both ends of the shield to the ground may cause a ground loop.

When removing the shield from the sensor end, make sure to properly trim the shield so as to prevent any chance of shorting. The current switch output terminals represent a solid-state switch for controlling AC and DC loads and is not polarity sensitive. The recommended torque to be used on the terminal block connections is 5.93 in-lbs. (0.67 Nm). The aperture (hole) size of the current switch is 3/4 in. (19 mm) and will accept a

SOLID CORE AND SPLIT CORE ADJUSTABLE CURRENT “STATUS” SWITCHES

maximum cable diameter of 350 MCM (17.3 mm). See Fig. 9 for use as a digital input to a building management system and Fig. 10 for use as a pilot relay application.

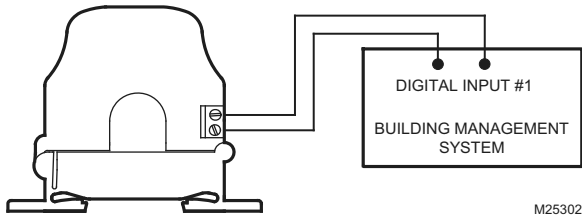

Fig. 9. Digital circuit

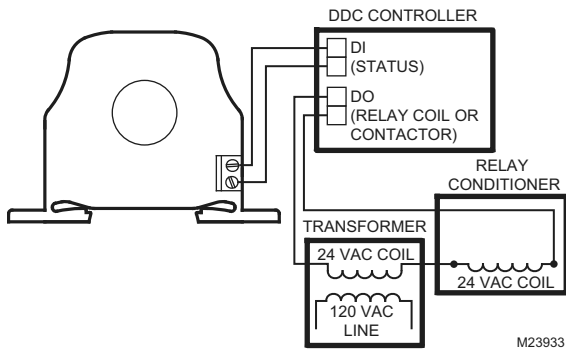

Fig. 10. Analog circuit

Calibration of Adjustable Trip Point

The adjustable current switch has an operating range of 0-250 Amps. Do not exceed! The adjustable current switch comes with its fifteen-turn adjustable potentiometer set counter-clockwise to its maximum position. The adjustable current switch can monitor Under load, Normal load and Overload conditions, depending on how it's set. The procedure below is for Normal load condition for part numbers CSS-O-A300-001 and CSS-O-A200-001.

Normal loads

With power on and the adjustable current switch on the proper range, turn the fifteen-turn adjustment potentiometer clockwise until the red LED turns on and stop immediately. The adjustment switch is now tripped. The adjustable current switch Hysteresis (Dead Band) is 10% of the trip point typically.

TROUBLESHOOTING

Problem	Solution
Red LED is on but the current switch didn't activate.	Disconnect the wires from the current switch output. Measure the resistance across the contacts with an Ohmmeter. See Table 2 below for resistance readings for a good unit.
Red LED didn't turn on and the current switch didn't activate	Verify that the conductor you are monitoring is above the adjustable trip point. If the sensor is monitoring less than the adjustable trip point, looping the wire may be required. See Fig. 5.
Sensor doesn't switch at all, regardless of current level.	Adjustment potentiometer is probably set to its maximum or minimum position. Turn the potentiometer clockwise all the way and verify if the LED switches from red to green.

Table 2. Resistance Readings For Good Unit.

Product Number	Resistance if switch is open	Resistance if switch is closed
CSS-O-A300-001	Greater than 1 Meg ohms	Approximately 2 ohms
CSS-O-A200-001	Greater than 1 Meg ohms	Approximately 2 ohms
CSS-C-A300-001	Greater than 1 Meg ohms	Approximately 12 ohms
CSP-O-A300-001	Greater than 1 Meg ohms	Approximately 2 ohms
CSP-O-A200-001	Greater than 1 Meg ohms	Approximately 2 ohms
CSP-C-A300-001	Greater than 1 Meg ohms	Approximately 12 ohms
CSP-C-A200-001	Greater than 1 Meg ohms	Approximately 12 ohms

SOLID CORE AND SPLIT CORE ADJUSTABLE CURRENT "STATUS" SWITCHES

SOLID CORE AND SPLIT CORE ADJUSTABLE CURRENT "STATUS" SWITCHES

Automation and Control Solutions

Honeywell International Inc.
1985 Douglas Drive North
Golden Valley, MN 55422
customer.honeywell.com

Honeywell Limited-Honeywell Limitée
35 Dynamic Drive
Toronto, Ontario M1V 4Z9

® U.S. Registered Trademark
© 2007 Honeywell International Inc.
63-2651—1 C.H. Rev. 06-07



Printed in U.S.A. on recycled
paper containing at least 10%
post-consumer paper fibers.

Honeywell