

MANUAL

VBG-PB-K20-(DM)D
AS-Interface/PROFIBUS-
Gateway





With regard to the supply of products, the current issue of the following document is applicable: The General Terms of Delivery for Products and Services of the Electrical Industry, published by the Central Association of the Electrical Industry (Zentralverband Elektrotechnik und Elektroindustrie (ZVEI) e.V.) in its most recent version as well as the supplementary clause: "Expanded reservation of proprietorship"

1	The Used Symbols	7
2	Safety	8
2.1	Intended use	8
2.2	General safety information	8
2.3	Waste disposal	8
3	General Information	9
4	AS-i Specification 3.0	10
5	Connections, Displays and Operating Keys	11
5.1	Single Master	12
5.1.1	Connections of the AS-i 3.0 PROFIBUS TCP/IP Gateway VBG-PB-K20-D	12
5.1.1.1	Function ground	13
5.2	Double Master	14
5.2.1	Connections of the AS-i 3.0 PROFIBUSGateway VBG-PB-K20-DMD	14
5.2.1.1	Function ground	15
5.2.2	PROFIBUS interface	15
5.2.3	Bus termination	16
5.3	Display and operating elements	16
5.3.1	LED-display Profibus	16
5.3.2	Push-buttons	17
6	Commissioning of the AS-i/PROFIBUS Gateway	18
6.1	Single Master VBG-PB-K20-D	18
6.1.1	Advanced display mode	18
6.1.2	Setting the PROFIBUS DP Address	18
6.1.3	Connecting AS-i Slaves	19
6.1.4	Quick setup	20
6.1.5	Error tracing	21
6.1.5.1	Faulty slaves	21
6.1.5.2	Error display (last error)	21
6.1.6	Addressing	22
6.1.6.1	Programming slave 2 to address 6	22
6.2	Double Master VBG-PB-K20-DMD	23
6.2.1	Advanced display mode	23
6.2.2	Setting the PROFIBUS DP address	23
6.2.3	Connecting AS-i Slaves	24
6.2.4	Quick setup	25
6.2.5	Error tracing	26
6.2.5.1	Faulty slaves	26
6.2.5.2	Error display (last error)	26
6.2.6	Addressing	27
6.2.6.1	Programming slave 2 to address 6	27
7	Operating in Advanced Display Mode	28
7.1	PROFIBUS (main menu)	31
7.1.1	PROFIBUS (PROFIBUS Station Address)	31

7.1.2	PROFIBUS Status	31
7.1.3	SET ADDR OVER PB (Set address over PROFIBUS)	31
7.1.4	I+M SERVICES (Information and maintenance services)	32
7.2	Quick setup	32
7.2.1	Control menu (option)	33
7.2.1.1	AS-i control	33
7.2.1.2	AS-i control information	33
7.2.1.3	AS-i control run	33
7.2.1.4	AS-i control flags (flag memory control program)	34
7.3	Slave Adr Tool (slave addressing tool)	34
7.4	Slave Test Tool	35
7.5	Setup (configuration of AS-i circuit)	37
7.5.1	AS-i circuit	37
7.5.2	Description of setup mode	37
7.5.3	AS-i Slave Adr (set/change slave address)	38
7.5.4	Force offline	38
7.5.5	Operation mode	38
7.5.6	Store Act Cfg (store actual detected configuration)	39
7.5.7	Permanent Param (projected parameter)	39
7.5.8	Permanent Config (projected configuration data)	39
7.5.9	AS-i address assistant	40
7.5.10	LOS (list of offline slaves)	40
7.5.11	Auto Adr Enable (enable automatic address)	40
7.5.12	Factory reset	41
7.6	IO + Param. Test	41
7.6.1	AS-i circuit	41
7.6.2	IO + Param. Test (Testing AS-i In- and Outputs as well as reading and writing AS-i Parameters)	42
7.6.3	Binary input	42
7.6.4	Binary outputs	43
7.6.5	Analog inputs	43
7.6.6	Analog outputs	44
7.6.7	Parameter	44
7.7	Diagnosis (normal AS-i diagnosis)	45
7.7.1	AS-i circuit	45
7.7.2	Diagnosis (normal AS-i diagnosis)	45
7.7.3	Flags	46
7.7.4	Actual Config (actual configuration)	48
7.7.5	LPF (List of periphery faults)	48
7.7.6	AS-i master (info)	49
7.8	Adv. Diagnosis (advanced AS-i diagnosis)	49
7.8.1	Error counters	49
7.8.2	LCS (list of slaves having caused a configuration error)	50
7.8.3	Fault detector	50
7.9	AS-i safety	51
7.9.1	Safety slaves (safety oriented slaves)	51
7.9.2	Safety monitor	52
7.9.3	Safety Subst Value	52

7.10	Display contrast	53
7.11	Language of displayed messages	53
8	Advanced Diagnostics for AS-i Masters	54
8.1	List of corrupted AS-i Slaves (LCS)	54
8.2	Protocol analysis: counters of corrupted data telegrams	54
8.3	Offline phase on configuration errors (LOS)	55
8.4	Functions of the AS-i fault detector	55
8.4.1	Duplicate address' recognition	55
8.4.2	Earth fault detector	56
8.4.3	Noise detector	56
8.4.4	Overvoltage detector	56
9	PROFIBUS DP	57
9.1	DP Telegrams	58
9.1.1	Diagnosis	58
9.1.1.1	Parameters	61
9.1.2	Configuration DP V0 (cyclic data)	63
9.1.2.1	Options	63
9.1.3	I/O Data	65
9.1.3.1	Process data	65
9.1.3.2	EC-Flags and AS-i watchdog	66
9.1.3.3	AS-i 16-bit data	67
9.1.3.4	Command Interface	67
9.2	DP V1	68
9.3	Restrictions	69
10	Command Interface	70
10.1	Construction	70
10.2	List of all commands	72
10.2.1	Values for results	74
10.3	Commands of the Command Interface	74
10.3.1	AS-i 16-bit data	74
10.3.1.1	Overview of the commands	74
10.3.1.2	Read 1 16-bit Slave in.Data (RD_7X_IN)	75
10.3.1.3	Write 1 16-bit Slave out.Data (WR_7X_OUT)	75
10.3.1.4	Read 1 16-bit Slave out.Data (RD_7X_OUT)	76
10.3.1.5	Read 4 16-bit Slave in.Data (RD_7X_IN_X)	76
10.3.1.6	Write 4 7.3 Slave out.Data (WR_7X_OUT_X)	77
10.3.1.7	Read 4 7.3 Slave out.Data (RD_7X_OUT_X)	77
10.3.1.8	Read 16 channels 16-bit Slave in.Data (OP_RD_16BIT_IN_CX)	78
10.3.1.9	Write 16 channels 16-bit slave out.Data (OP_WR_16BIT_IN_CX)	78
10.3.2	Commands acc. to Profile S-7.4/S-7.5	79
10.3.2.1	Overview of the commands	79
10.3.2.2	WR_74_75_PARAM	79
10.3.2.3	RD_74_75_PARAM	80
10.3.2.4	RD_74_75_ID	81
10.3.2.5	RD_74_DIAG	81
10.3.3	Acyclic commands	82

10.3.3.1	Overview of the commands	82
10.3.3.2	WRITE_ACYCLIC_TRANS	82
10.3.3.3	READ_ACYCLIC_TRANS	84
10.3.4	AS-i Diagnosis	85
10.3.4.1	Overview of the commands	85
10.3.4.2	Get Lists and Flags (Get_LPS, Get_LAS, Get_LDS, Get_Flags) (GET_LISTS)	85
10.3.4.3	Get Flags (GET_FLAGS)	87
10.3.4.4	Get Delta List (GET_DELTA)	88
10.3.4.5	Get list of corrupted Slaves (GET_LCS and GET_LCS_R6 (6CH))	89
10.3.4.6	Get list of activated Slaves (GET_LAS)	89
10.3.4.7	Get list of detected AS-i Slaves (GET_LDS)	90
10.3.4.8	Get list of peripheral faults (GET_LPF)	91
10.3.4.9	Get list of offline Slaves (GET_LOS)	91
10.3.4.10	Set list of offline Slaves (SET_LOS and SET_LOS_R6 (6Dh))	92
10.3.4.11	Get transm.err.counters (GET_TECA)	93
10.3.4.12	Get transm.err.counters (GET_TECB)	94
10.3.4.13	Get transm.err.counters (GET_TEC_X)	94
10.3.4.14	Read fault detector (READ_FAULT_DETECTOR)	95
10.3.4.15	Read list of duplicate addresses (READ_DUPLICATE_ADDR)	96
10.3.5	Configuration of AS-i Master	97
10.3.5.1	Overview of the commands	97
10.3.5.2	Set operation mode (SET_OP_MODE: Set_Operation_Mode)	97
10.3.5.3	Store actual configuration (STORE_CDI)	98
10.3.5.4	Read actual configuration (READ_CDI)	98
10.3.5.5	Set permanent configuration (SET_PCD)	99
10.3.5.6	Get extended permanent configuration (GET_PCD)	100
10.3.5.7	Set list of projected slaves (SET_LPS and SET_LPS_R6 (6Bh))	100
10.3.5.8	Get list of projected slaves (GET_LPS)	101
10.3.5.9	Store actual parameters (STORE_PI)	102
10.3.5.10	Write parameter (WRITE_P)	102
10.3.5.11	Read parameter (READ_PI: Read_Parameter)	103
10.3.5.12	Set permanent parameter (SET_PP)	103
10.3.5.13	Get permanent parameter (GET_PP)	104
10.3.5.14	Set auto address enable (SET_AAE)	104
10.3.5.15	Change slave address (SLAVE_ADDR)	105
10.3.5.16	Write AS-i slave extended ID1 (WRITE_XID1)	106
10.3.6	Other commands	106
10.3.6.1	Overview of the commands	106
10.3.6.2	IDLE	107
10.3.6.3	Read input data image (READ_IDI)	108
10.3.6.4	Write output data image (WRITE_ODI)	109
10.3.6.5	Read output data image (READ_ODI)	109
10.3.6.6	Set offline mode (SET_OFFLINE)	110
10.3.6.7	Release data exchange (SET_DATA_EX)	111
10.3.6.8	BUTTONS	111
10.3.6.9	FP_PARAM	111
10.3.6.10	FP_DATA	112
10.3.6.11	EXT_DIAG	112

Issue date 24.8.2007

10.3.6.12	RD_EXT_DIAG	113
10.3.6.13	Inverter	114
10.3.6.14	Write Flag	114
10.3.6.15	Read Flag	115
10.3.6.16	READ_MFK_PARAM	115
10.4	Functional profiles	116
10.4.1	"Safety at Work" List 1	116
10.4.2	"Safety at Work" Monitor diagnosis	118
10.4.2.1	Setting of the AS-i diagnosis	118
10.4.2.2	Enhanced diagnosis	120
10.4.3	Integrated AS-i Sensors: Warnings	124
10.4.4	Integrated AS-i sensors: Availability	125
10.4.5	Language-select	125
10.4.6	Replacement of Safety Slaves input data	126
10.4.7	List of Safety Slaves	127
10.5	Command Interface examples	128
10.5.1	Reading 16-bit input values	128
10.5.2	Store current configuration to the AS-i master	129
10.5.3	Store new configuration for all slaves	133
11	Commissioning Tools	141
11.1	Windows software AS-i Control Tools	141
11.1.1	PROFIBUS DP Master Simulator	144
12	Appendix: Example for startup on a Siemens S7	146
12.1	Hardware configuration	146
12.1.1	Electrical connection for AS-i	146
12.1.2	Electrical connection for PROFIBUS-DP	147
12.2	SIMATIC Step Configuration	147
12.2.1	Configuration of the Hardware	147
12.2.2	Insert AS-i/PROFIBUS Gateway	150
12.2.3	Configuring AS-i/PROFIBUS-Gateway in-/output	152
12.2.4	AS-i/PROFIBUS Gateway PROFIBUS DP parameters	154
12.2.4.1	General DP parameters	155
12.2.4.2	Device-specific parameters	155
12.2.4.3	Hex parameterizing	158
12.2.5	SIMATIC StepS7 blocks	158
12.2.6	Variable table VAT_ASI_IO	159
12.2.6.1	AS-i flags byte 0, input bits 7 - 4	161
12.2.6.2	AS-i flags byte 0, output bits 7 - 4	161
12.2.7	System behavior on AS-i Config Error	163
13	Appendix: Codes indicated by the Display	167
14	Appendix: Installation Instructions	169
14.1	Listing of all described gateways	169
14.2	VBG-PB-K20-D	170
14.2.1	Dimensions	170
14.2.2	Front view and connections	171

14.2.3	Startup	172
14.2.3.1	Switching to advanced display mode	172
14.2.4	Setting the PROFIBUS-DP address	172
14.2.5	Connecting AS-i Slaves	173
14.2.6	Quick setup	174
14.2.7	Error tracing	175
14.2.7.2	Faulty slaves	175
14.2.7.3	Error display (last error)	175
14.2.8	Addressing	176
14.2.8.4	Program slave 0 to address 4	176
14.2.9	Montage	177
14.2.10	Accessories	177
14.3	VBG-PB-K20-DMD	178
14.3.1	Dimensions	178
14.3.2	Front view and connections	179
14.3.3	Startup	180
14.3.3.5	Switching to advanced display mode	180
14.3.4	Setting the PROFIBUS-DP address	180
14.3.5	Connecting AS-i Slaves	181
14.3.6	Quick setup	182
14.3.7	Error tracing	183
14.3.7.6	Faulty slaves	183
14.3.7.7	Error display (last error)	183
14.3.8	Addressing	184
14.3.8.8	Programming slave 2 to address 6	184
14.3.9	Montage	185
14.3.10	Accessories	185
15	Glossary: AS-i Terms	186

1 The Used Symbols

 <p>Warning</p>	<p>This symbol warns the user of possible danger. Not following this warning can lead to personal injury or death and/or destruction of the equipment.</p>
---	--

 <p>Attention</p>	<p>This symbol warns the user of a possible failure. Not following this warning can lead to total failure of the device or any other connected equipment.</p>
---	---

 <p>Note</p>	<p>This symbol draws the user's attention to important information.</p>
--	---

2 Safety

2.1 Intended use

 <p>Warning</p>	<p>The protection of operating personnel and the system against possible danger is not guaranteed if the control interface unit is not operated in accordance with its intended use.</p> <p>The device may only be operated by appropriately qualified personnel in accordance with this operating manual.</p>
--	--

2.2 General safety information

 <p>Warning</p>	<p>Safety and correct functioning of the device cannot be guaranteed if any operation other than that described in this operation manual is performed.</p> <p>Connecting the equipment and any maintenance work to be carried out with voltage applied to the equipment must exclusively be performed by appropriately qualified electrotechnical personnel.</p> <p>In case a failure cannot be repaired, the device must be taken out of operation and kept from inadvertently being put back into operation.</p> <p>Repair work is to be carried out by the manufacturer only. Additions or modifications to the equipment are not allowed and will void the warranty.</p>
--	--

 <p>Note</p>	<p>The operator is responsible for the observance of local safety standards.</p>
--	--

2.3 Waste disposal

 <p>Attention</p>	<ul style="list-style-type: none"> • All devices and components are to be used properly! • Non-usable electrical components are hazardous waste and they should be disposed separately! • Local and national guide lines during waste disposal are to be respected!
--	--

3 General Information

This operating instruction holds for the following devices of the Pepperl+Fuchs GmbH:

VBG-PB-K20-D	AS-i 3.0 PROFIBUS Gateway in stainless steel, single master
VBG-PB-K20-DMD	AS-i 3.0 PROFIBUS Gateway in stainless steel, double master

The AS-i/PROFIBUS Gateways are designated to connect AS-i systems with a superior PROFIBUS. They act as a master for the AS-i and as a slave for the PROFIBUS.

4 AS-i Specification 3.0

The AS-i/PROFIBUS gateways already fulfil the new AS-i Specification 3.0.

The previous specifications (2.1 and 2.0) are supported as well.

All AS-i functions are provided as well cyclically as acyclically via PROFIBUS DP V1.

In the cyclic data transfer optionally up to 32 bytes I/O data are being transferred for the binary data of one AS-i network. Additionally, analog signals and all further commands of the new AS-i specification can be transferred in the management channel via PROFIBUS.

The serial PROFIBUS Master and the AS-i Control Tools can be used for monitoring the AS-i data online via the PROFIBUS DP V1.

Advanced Diagnostics

Diagnostics, which go far beyond the standard diagnostics, facilitate the simple detection of occasionally occurring configuration errors and further irritations influencing the AS-i communication. In case of an error, the down time of machines can be minimized or preventive maintenance can be initiated.

Commissioning and monitoring

The AS-i/PROFIBUS Gateways can be commissioned or programmed with the help of the software "AS-i Control Tools" in combination with the PROFIBUS DP master simulator. The GSD file is included in the package.

Commissioning, debugging and setting up the AS-i parameters without the software can be accomplished by directly using the system's push-buttons, the display and the LEDs.

Accessories:

Software "AS-i Control Tools"
PROFIBUS DP master simulator.



Note

Please view <chapter 11 > for further accessories.

5 Connections, Displays and Operating Keys

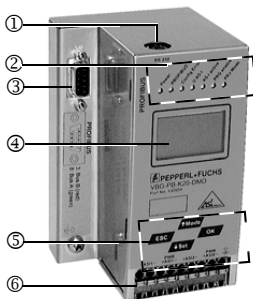



On the front panel of the device in stainless steel housing are located:

- [1] RS 232 diagnostic interface (only in connection with "AS-i Control Tools")
- [2] LEDs
- [3] SUB-D connector as PROFIBUS interface
- [4] LC display
- [5] Push-buttons to configure the device
- [6] Terminals to connect the power supply and the AS-i circuit.

5.1 Single Master

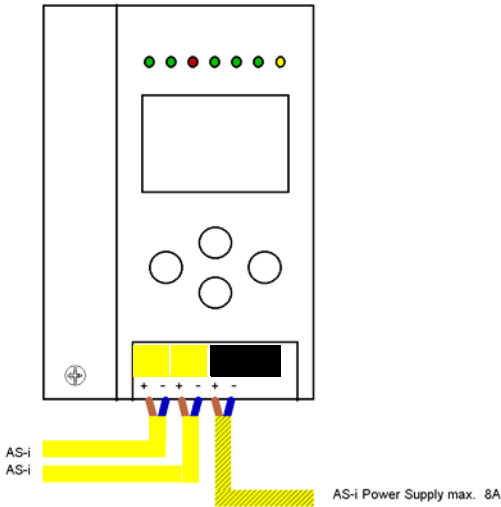
5.1.1 Connections of the AS-i 3.0 PROFIBUS TCP/IP Gateway VBG-PB-K20-D



 Note	It is not allowed to connect AS-i power supplies or another master to the yellow marked cable.
--	--

 Note	It is not allowed to connect slaves or repeaters to the hatched marked cable.
---	---

5.1.1.1 Function ground

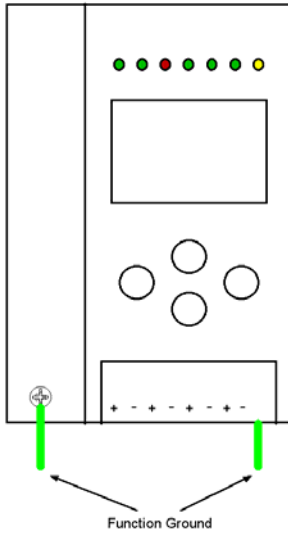



Note

- The function ground can be connected either at the ground screw or at the terminal.
- The function ground should be connected with a cable as short as possible to guarantee a good EMC property.
- Therefore it is preferred to connect the ground via the ground screw.

5.2 Double Master

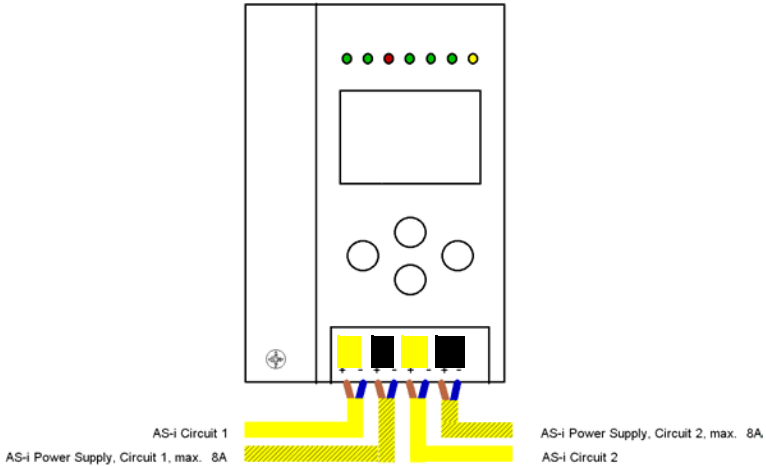
5.2.1 Connections of the AS-i 3.0 PROFIBUSGateway VBG-PB-K20-DMD





 Note	AS-i circuit 1 and 2 are powered by separate power supplies.
--	--

 Note	It is not allowed to connect slaves or repeaters to the hatched marked cable.
--	---

 Note	It is not allowed to connect AS-i power supplies or another master to the yellow marked cable.
--	--

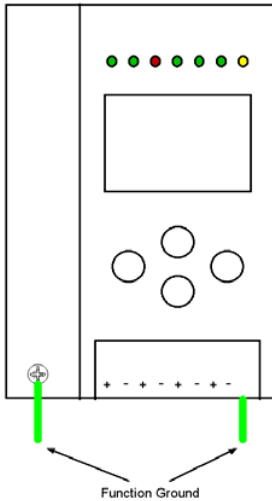
5.2.1.1 Function ground



 Note	<ul style="list-style-type: none"> • The function ground can be connected either at the ground screw or at the terminal. • The function ground should be connected with a cable as short as possible to guarantee a good EMC property. • Therefore it is preferred to connect the ground via the ground screw.
--	---

5.2.2 PROFIBUS interface

The PROFIBUS interface is realized as a 9-pin SUB-D connector, in accordance with the standard for PROFIBUS DIN 19245. It is placed at the top left-hand side of the master.

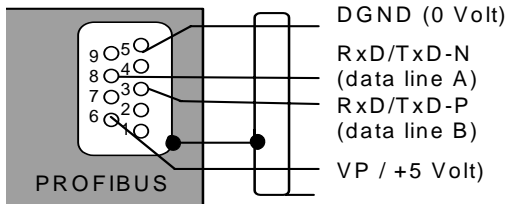

The AS-i/PROFIBUS gateway sends and receives on pins 3 and 8 of the SUB-D socket. The PROFIBUS signal "Rx/D/TxD-N (data line A)"¹ is located on pin 8, the signal "Rx/D/TxD-P (data line B)"¹ is located on pin 3.

The pins 5 (0 V) and 6 (5 V) supply 5 V DC for the bus termination.

Issue date - 24.8.2007

1. If you measure the DC voltage between Rx/D/TxD-P (data line B) and Rx/D/TxD-N (data line A), Rx/D/TxD-P (data line B) is the positive pole when the bus is silent.

5.2.3 Bus termination

If the PROFIBUS gateway is connected at the end of the PROFIBUS line, the termination resistors in the PROFIBUS connector have to be switched on.

PIN	Designation of the SUB-D connectors
Pin 3	Data line B („RxD/TxD-P“)
Pin 5	DGND (0 V)
Pin 6	VP / +5 V
Pin 8	Data line A („RxD/TxD-N“)

Terminating resistors with RS 485:

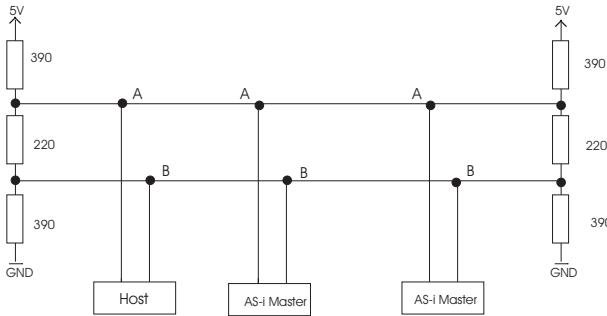

5.3 Display and operating elements

5.3.1 LED-display Profibus

There are seven light-emitting diodes on the front panel of the gateway . They have the following function:

- Power** The master's power supply is sufficient.
- Profibus** LED on: Gateway is allocated to a PROFIBUS master.
LED off: Gateway is not allocated to a PROFIBUS master.
- Config err** Configuration error:
At least one configured slave is missing, at least one detected slave is not projected or for at least one projected and detected slave the actual configuration data does not match the nominal configuration data.
This LED flashes if there is at least one periphery fault at one AS-i slave in the AS-i network. If there are configuration errors as well as periphery faults, only configuration error is displayed.
- U AS-i** The AS-i circuit is sufficiently powered.
- AS-i active** Normal operation active (Flashes, if a B-slave is displayed).

Issue date - 24.8.2007

prg enable Automatic address programming enabled.
Exactly one slave is missing in protected operating mode. The slave can be replaced by another slave of the same type with address zero. The master addresses the new slave to the faulty address and thus eliminates the configuration error.

prj mode The AS-i master is in configuration mode.

5.3.2 Push-buttons

The push-buttons cause the following:

Mode/↑> Switching between configuration mode and protected operating mode and saving the current AS-i configuration as the nominal configuration.

Set/↓ Selecting and assigning the address to a slave.

OK, ESC Changing to the advanced display mode (see <).

6 Commissioning of the AS-i/PROFIBUS Gateway

6.1 Single Master VBG-PB-K20-D

6.1.1 Advanced display mode

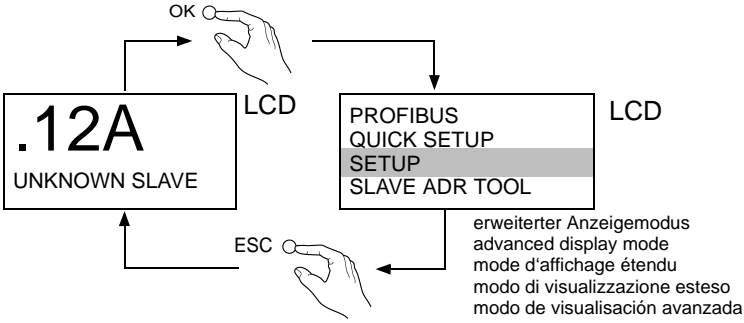

klassische Anzeige
classical display
affichage classique
display classico
indicación clásica



Aufbau siehe Zusatzblatt
structure see additional page
structure voir page supplémentaire
struttura vedi pagina supplementare
estructura ver página adicional

6.1.2 Setting the PROFIBUS DP Address

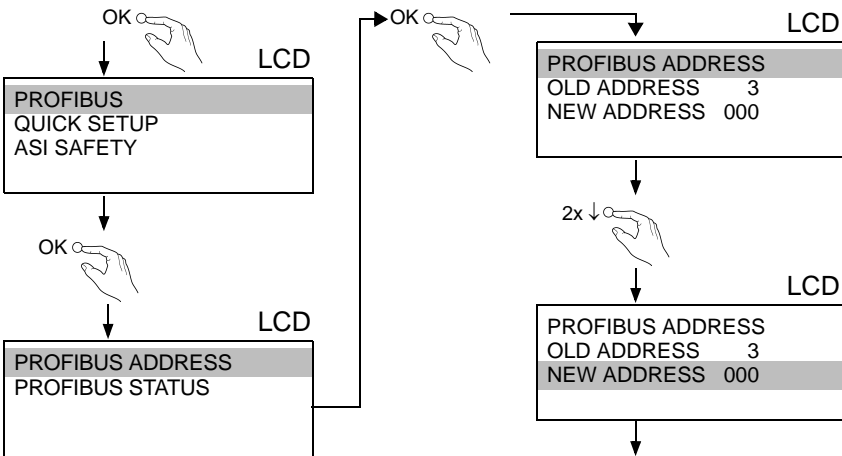

Issue date - 24.8.2007

AS-i/PROFIBUS Gateway Commissioning of the AS-i/PROFIBUS Gateway

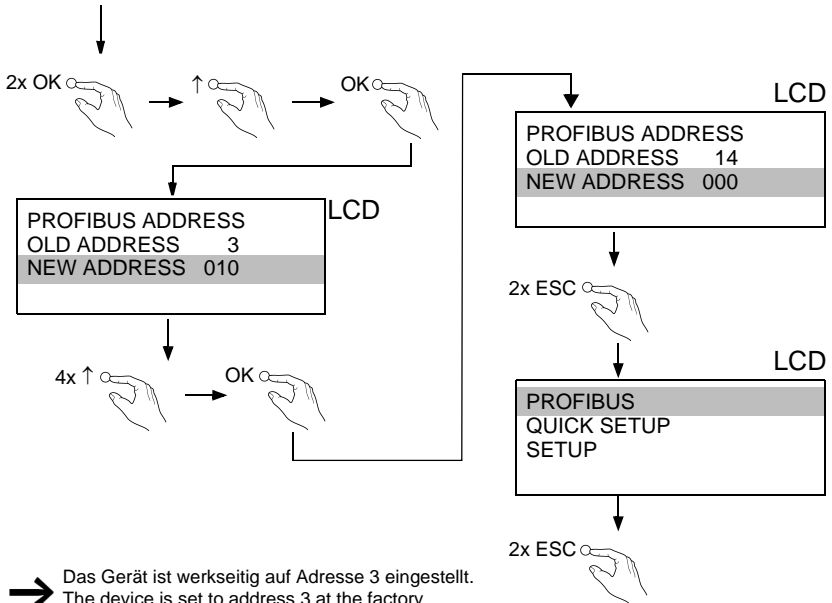

➔ Das Gerät ist werkseitig auf Adresse 3 eingestellt.
The device is set to address 3 at the factory.
L'appareil est réglé en usine à l'adresse 3.
L'apparecchio è messo all'indirizzo 3 dalla fabbrica.
El aparato viene ajustado de fábrica con la dirección 3.

6.1.3 Connecting AS-i Slaves

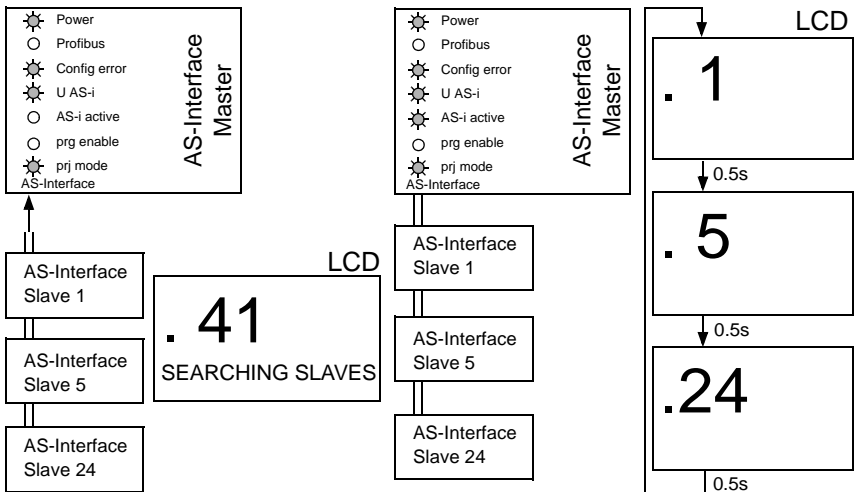

6.1.4 Quick setup

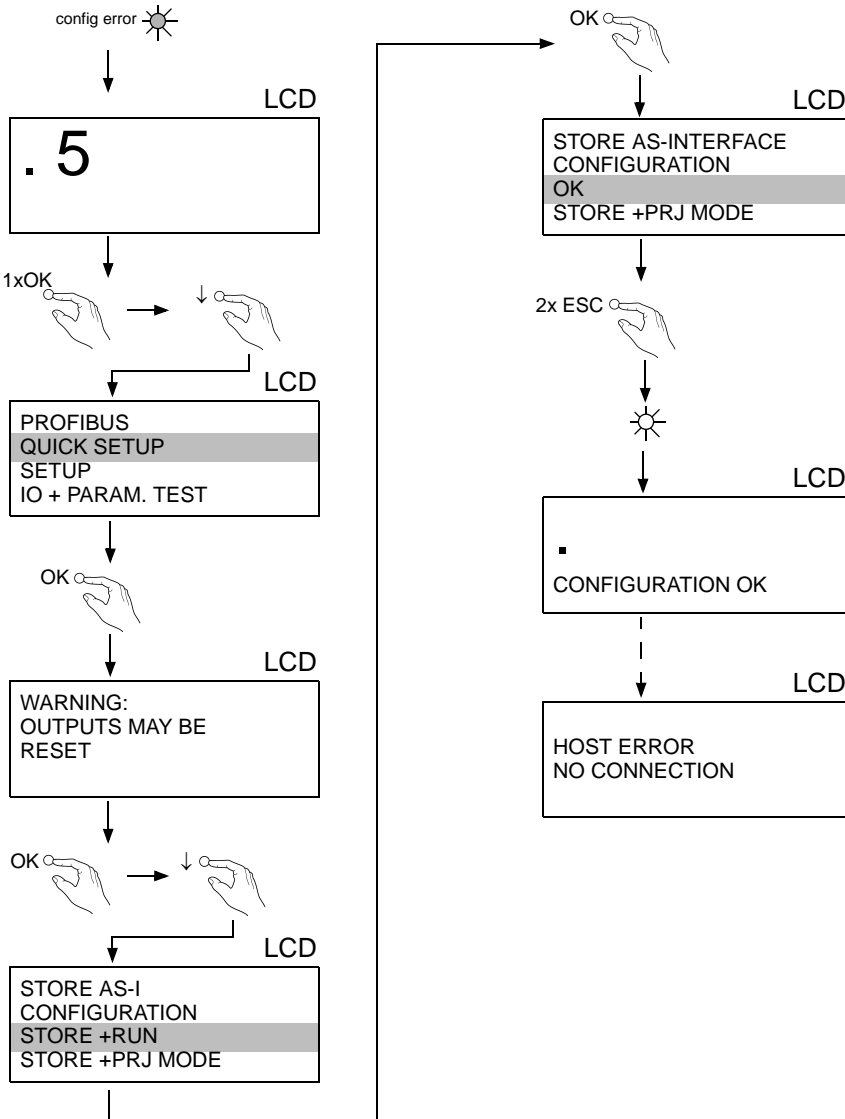

Issue date - 24.8.2007

AS-i/PROFIBUS Gateway Commissioning of the AS-i/PROFIBUS Gateway

6.1.5 Error tracing

6.1.5.1 Faulty slaves



6.1.5.2 Error display (last error)

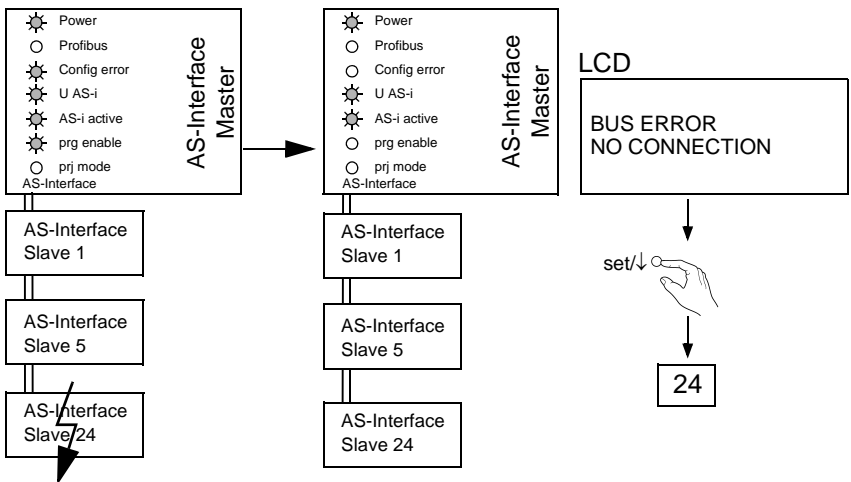

6.1.6 Addressing

6.1.6.1 Programming slave 2 to address 6

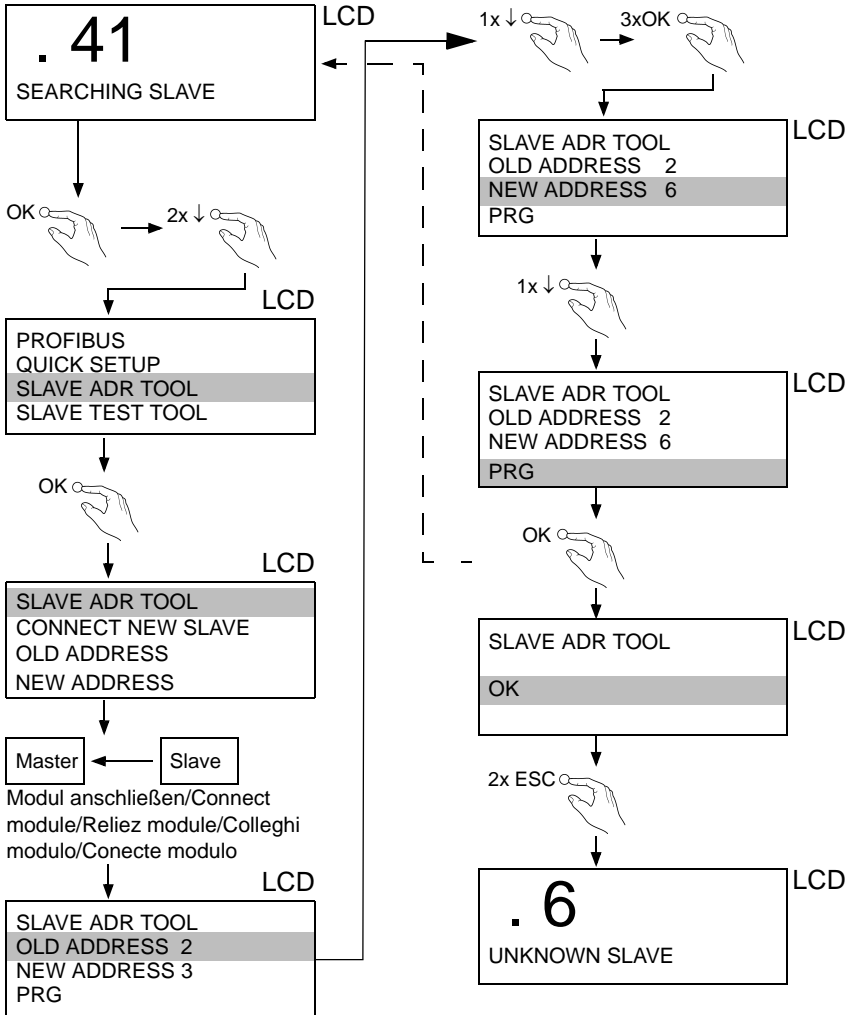

AS-i/PROFIBUS Gateway Commissioning of the AS-i/PROFIBUS Gateway

6.2 Double Master VBG-PB-K20-DMD

6.2.1 Advanced display mode

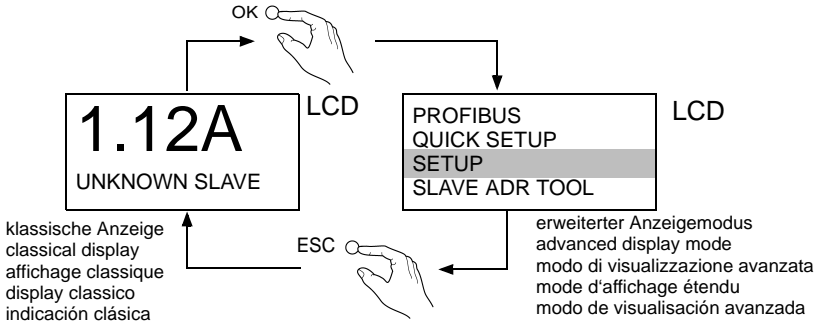

Aufbau siehe Zusatzblatt
 structure see additional page
 structure voir page supplémentaire
 struttura vede pagina supplementare
 estructura ver página adicional

6.2.2 Setting the PROFIBUS DP address

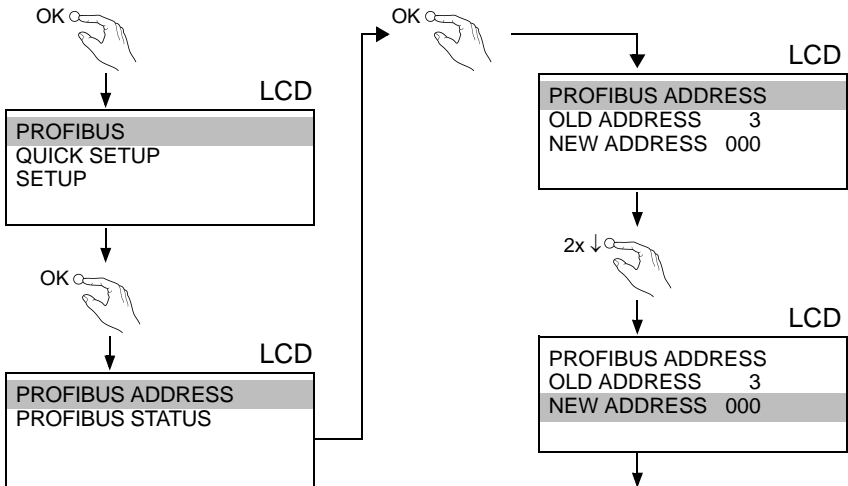

Issue date - 24.8.2007

AS-Interface Commissioning of the AS-i/PROFIBUS Gateway

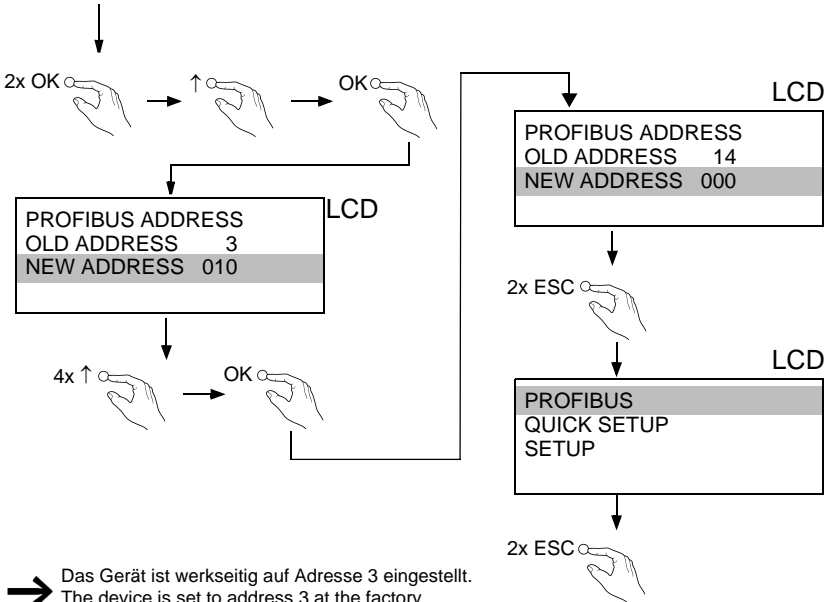

➔ Das Gerät ist werkseitig auf Adresse 3 eingestellt.
 The device is set to address 3 at the factory.
 L'appareil est réglé en usine à l'adresse 3.
 L'apparecchio è messo all'indirizzo 3 dalla fabbrica.
 El aparato viene ajustado de fábrica con la dirección 3.

6.2.3 Connecting AS-i Slaves

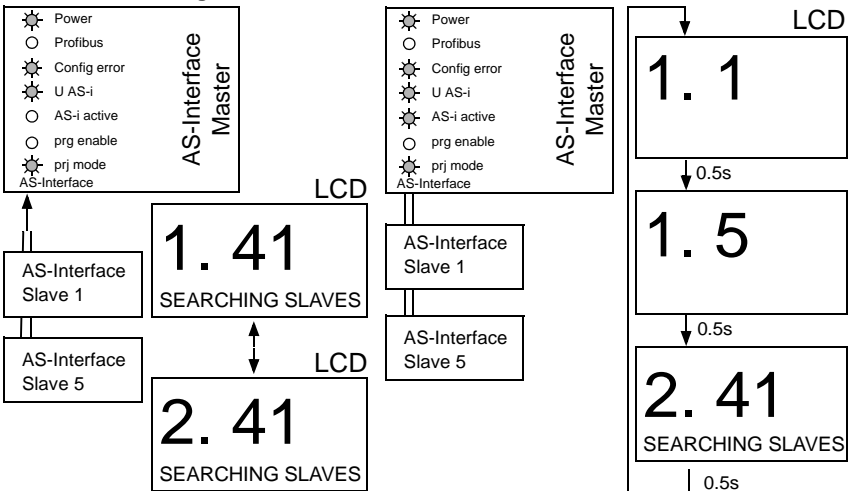

Issue date - 24.8.2007

6.2.4 Quick setup

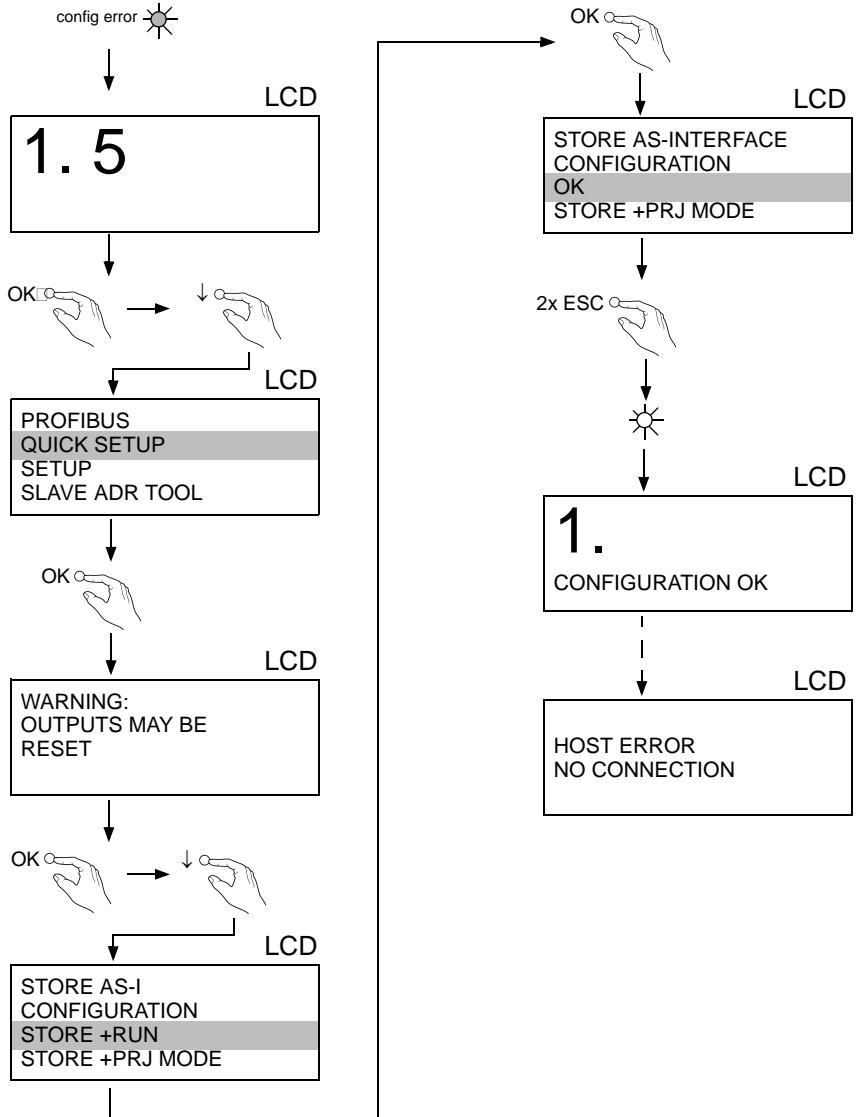

6.2.5 Error tracing

6.2.5.1 Faulty slaves



6.2.5.2 Error display (last error)

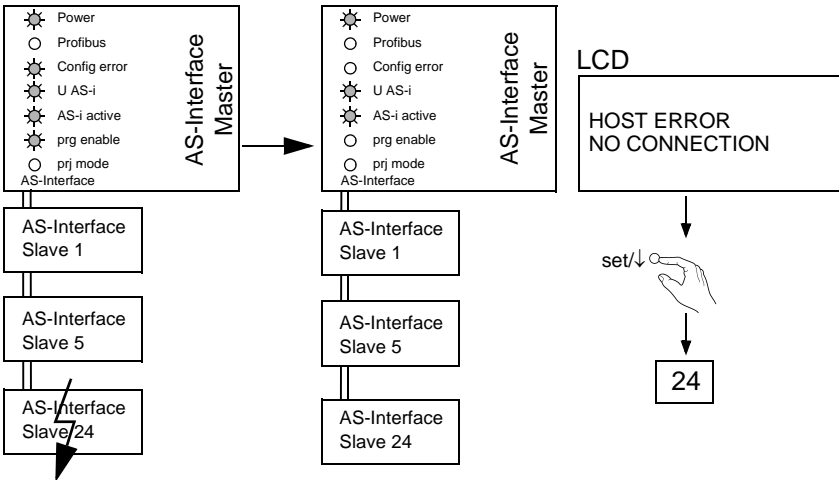

6.2.6 Addressing

6.2.6.1 Programming slave 2 to address 6

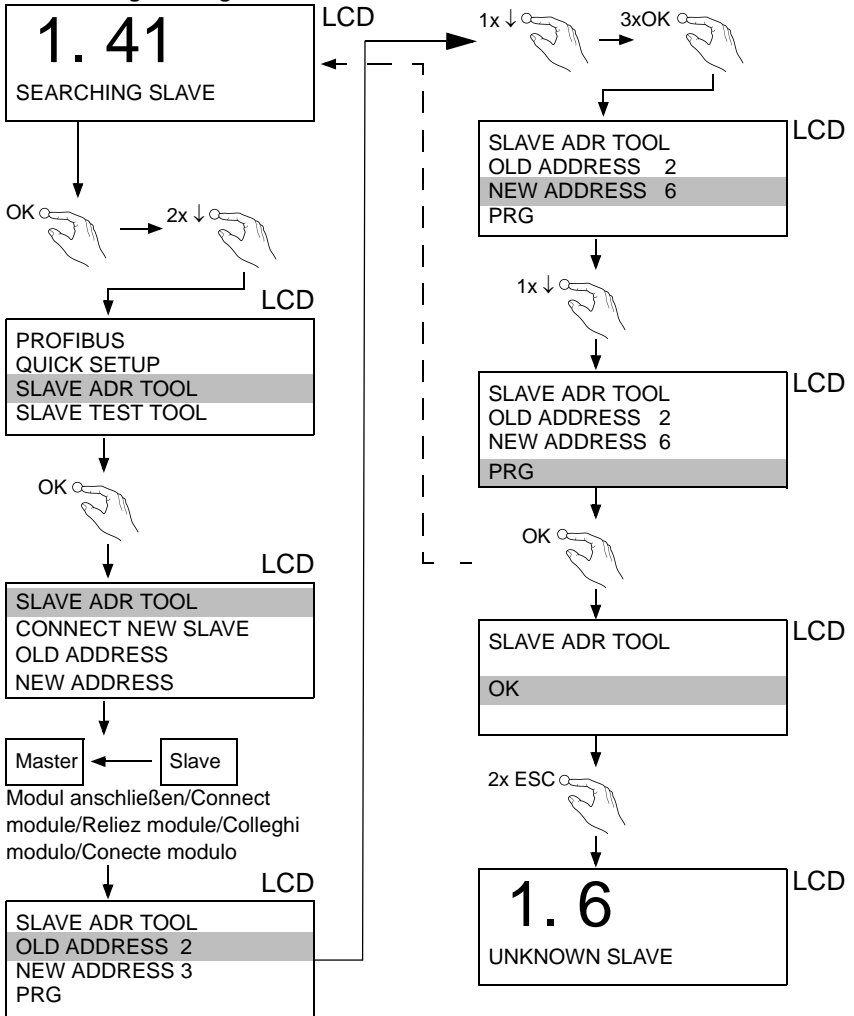

7 Operating in Advanced Display Mode

AS-i 3.0 PROFIBUS-Gateway: Inbetriebnahme/Commissioning

Klassischer Modus / Classic Mode

1.12A

grün markierte Werte sind editierbar
green marked data can be edited

Erweiterter Display Modus / Advanced Display Mode

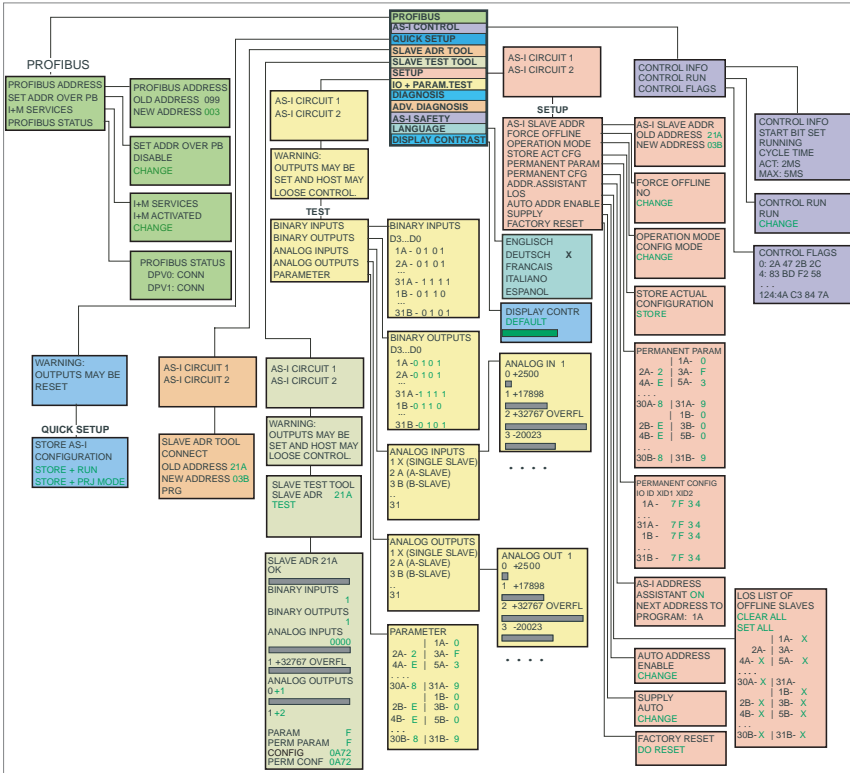

Grundsätzliche Bedienung

Das Gerät startet im traditionellen Modus. Mit ESC oder OK kann zwischen beiden Modi gewechselt werden. Im erweiterten Modus wird ein Cursor mit den beiden Pfeil-Tasten bewegt. OK bringt ins nächsthöhere Menü (in der Zeichnung weiter nach rechts). ESC bringt zurück ins vorherige Menü. Wenn Werte editiert werden, werden sie zunächst mit dem Cursor markiert, dann mit OK ausgewählt, mit den Pfeiltasten verändert und schließlich mit OK übernommen. ESC bricht das Editieren ab.

Basic Operation

The device starts in the traditional mode. You can switch between the two modes with (ESC or OK). In the advanced mode the cursor is moved by both arrow buttons. Pushing OK puts you to the superior menu (in the drawing one step to the right side). ESC puts you back to the previous menu. To edit data you first mark them with the cursor and then select them with OK, change them with the arrow buttons and finally apply them with OK. Pushing ESC cancels the editing.

Issue date - 24.8.2007

AS-i/PROFIBUS Gateway AS-i/PROFIBUS-Gateway Operating in Advanced Display Mode

AS-i 3.0 PROFIBUS-Gateway: Inbetriebnahme/Commissioning

Klassischer Modus / Classic Mode

1.12A

grün markierte Werte sind editierbar
green marked data can be edited

Erweiterter Display Modus / Advanced Display Mode

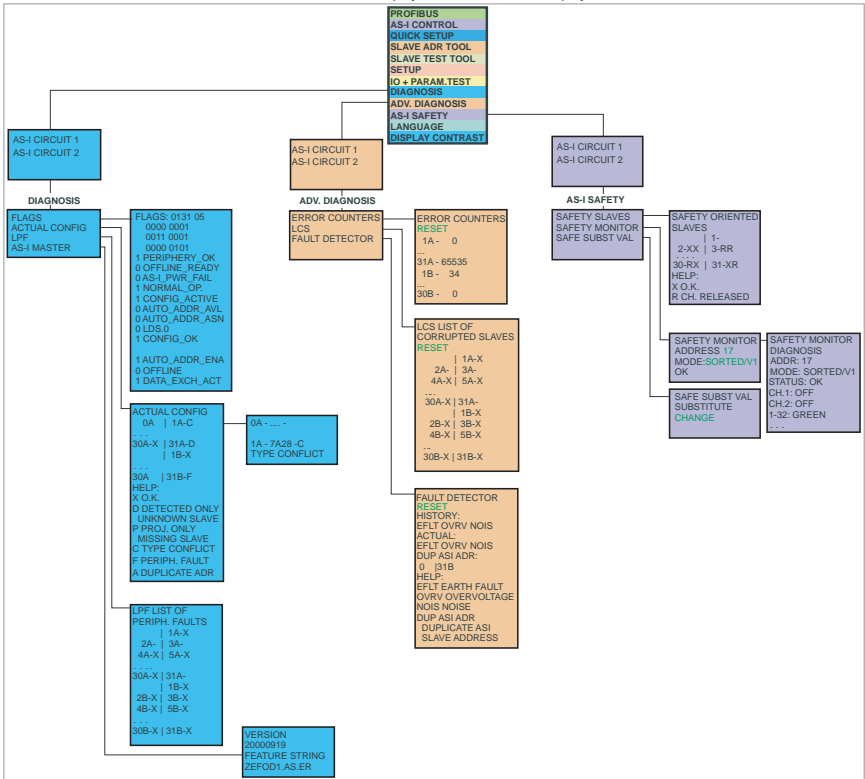

Grundsätzliche Bedienung

Das Gerät startet im traditionellen Modus. Mit ESC oder OK kann zwischen beiden Modi gewechselt werden. Im erweiterten Modus wird ein Cursor mit den beiden Pfeil-Tasten bewegt. OK bringt ins nächsthöhere Menü (in der Zeichnung weiter nach rechts). ESC bringt zurück ins vorherige Menü. Wenn Werte editiert werden, werden sie zunächst mit dem Cursor markiert, dann mit OK ausgewählt, mit den Pfeiltasten verändert und schließlich mit OK übernommen. ESC bricht das Editieren ab.

Basic Operation

The device starts in the traditional mode. You can switch between the two modes with ESC or OK. In the advanced mode the cursor is moved by both arrow buttons. Pushing OK puts you to the superior menu (in the drawing one step to the right side). ESC puts you back to the previous menu. To edit data you first mark them with the cursor and then select them with OK, change them with the arrow buttons and finally apply them with OK. Pushing ESC cancels the editing.

Issue date - 24.8.2007



Warning

Classical (Traditional) mode does not guarantee any protection of the settings at the device!
In the classical mode, it is possible to change settings while the device is in operation. This can lead to failure of the plant (e. g. changing the address of an AS-i slave).

1.12 A

PROFIBUS
AS-I CONTROL
QUICK SETUP
SLAVE ADDR TOOL
SLAVE TEST TOOL
SETUP
IO+PARAM.TEST
DIAGNOSIS
ADV.DIAGNOSIS
AS-I SAFETY
LANGUAGE
CONTRAST



Hinweis

The settings in the advanced mode are protected, as long as the PROFIBUS Master Class 1 is running. That means that some states are indicated only. Many operations (for example: "change address", "write parameter", "set outputs", and so forth) are not possible via the display during the connection with the control (active PROFIBUS masters Class 1Busconnection) for the protection of the plant. Before these commands can be executed at the display, first the connection (PROFIBUS Master Class 1 connection) to the control must be deactivated.

The device starts in the classical mode (see chapter 7). Press OK to switch to the advanced mode.

In the extended mode, the selection can be moved up and down with the arrow buttons.

Pressing OK will switch you to the selected function or menu. Pressing ESC will switch you back to the previous menu.

To edit data values highlight them with the selection bar, press OK, then change them with the arrow-buttons and confirm with OK. The ESC-button cancels the editing process.

All possible addresses are displayed one after the other from 1A to 31A and from 1B to 31B. Data for single slaves are displayed at the addresses 1A - 31A.

7.1 PROFIBUS (main menu)

7.1.1 PROFIBUS (PROFIBUS Station Address)



This function is used for the setting and changing of the PROFIBUS station address.

The number behind "Old Address" shows the actual station address. By selecting "New Address", this address can be changed.

7.1.2 PROFIBUS Status

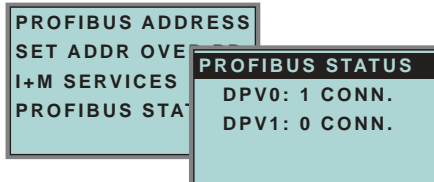

The function *PROFIBUS Status* indicates if and how many connections are active on each PROFIBUS channel.

DPV0 = cyclic channel:

- 0: not active
- 1: active

DPV1 = acyclic channel:

- 0: not active
- ≠0: number of connections

7.1.3 SET ADDR OVER PB (Set address over PROFIBUS)

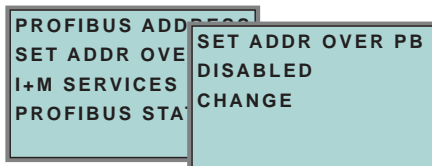

With the help of this function changing the address over the PROFIBUS can be switched off and on.

- CHANGE: the display changes between ENABLED and DISABLED
- DISABLED: address modification over BUS is not possible.
- ENABLED: address modification over BUS is possible.

7.1.4 I+M SERVICES (Information and maintenance services)



I+M SERVICES
DISABLED
CHANGE

The function *I+M SERVICES* enables or disables the information and maintenance service.

- CHANGE: the display changes between ENABLED and DISABLED

DISABLED: I+M service is *off*

ENABLED: I+M service is *on*.

Switching-off of *I+M SERVICES* sets additional memory in the SPC3 free. The DPV0 length limit will be modified <see chapter 9.3>.

7.2 Quick setup

This menu enables a fast configuration of the AS-i network.



WARNING:
OUTPUTS MAY BE
RESET

 <p>Warning</p>	Warning: outputs may be reset!
---	--------------------------------

Pressing "OK" you switch to the submenu "Store AS-i Configuration".

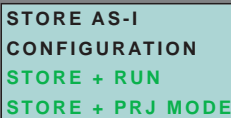

STORE AS-I
CONFIGURATION
STORE + RUN
STORE + PRJ MODE

"Store+Run"

With "OK" you store the current AS-i network configuration and the attached slaves as the target configuration. The gateway changes into the protected operating mode.

"Store+Prj Mode"

With "OK" you store the current AS-i network configuration and the attached slaves. The gateway remains in the *project mode*.

By pressing the "ESC" button you leave this menu and switch back to the main menu.

7.2.1 Control menu (option)

7.2.1.1 AS-i control

```
CONTROL INFO
CONTROL RUN
CONTROL FLAGS
```

7.2.1.2 AS-i control information

```
CONTROL INFO
START BIT SET
RUNNING
CYCLE TIME
ACT:      2 MS
MAX:      5 MS
```

This function displays the current status of the AS-control (control program).

START BIT SET: the control program was started.

START BIT RESET: the control program was stopped.

RUNNING: the control program is running.

STOPPED: the control program was stopped.

The control program can be stopped even though the start bit was set. Example: any configuration error occurs, or the master is in the configuration mode.

CYCLE TIME ACT: current cycle time of the control program.

CYCLE TIME MAX: maximal cycle time of the control program since its last start.

7.2.1.3 AS-i control run

```
CONTROL RUN
RUN
CHANGE
```

CONTROL RUN: the control program can be stopped with this function. It modifies the start bit in the menu Control Info.

RUN: the control program has been started. Even if the start bit is set, the control program can be stopped; example: any configuration error occurs, or the master is in the configuration mode.

CHANGE: the configuration program is stopped.

7.2.1.4 AS-i control flags (flag memory control program)

CONTROL	FLAGS
0:2A 47 2B 2C	
4:83 BD F2 58	
...	
124: 4A C3 84 7A	

The control program can read and modify the flag memory with the function "AS-i Control flags".

A procedure of modifying flag memory:

- select a line with soft keys
- press *OK* to open the selected menu

5:10111101
4:83 BD F2 58

- select the required flag with hot keys (the selected flag appears in the upper line binary coded)
- press *OK* to edit the selected flag in the upper line.

7.3 Slave Adr Tool (slave addressing tool)

This function sets and changes the addresses of both new and configured AS-i slaves. This function replaces the handheld AS-i address programming device.

AS-I CIRCUIT 1
AS-I CIRCUIT 2

Please note that you must have selected the desired AS-i circuit using the arrow and the *OK* button when you operate a device with two AS-i circuits (see chapter 7.5.1).

SLAVE ADR TOOL
CONNECT NEW SLV
OLD ADDRESS
NEW ADDRESS

Now the new slave can be connected to the AS-i circuit. After connecting the actual address of the slave is displayed by "OLD ADDRESS".and the notice "CONNECT NEW SLV" disappears.

To give the slave a new address choose the menu entry "NEW ADDRESS". Afterwards the address can be selected with the help of the arrow buttons. The (re-)addressing is carried out by selecting the menu entry "PRG" and pressing the OK button.

```
SLAVE ADR TOOL
OLD ADDRESS 21A
NEW ADDRESS 03B
PRG
```

If an error occurs while addressing a slave, one of the following error messages is displayed for about 2 seconds:

- Failed: SND:slave with old address has not been detected.
- Failed: SD0:slave with address zero has been detected.
- Failed: SD2:slave with new address has been detected.
- Failed: DE:could not delete old address.
- Failed: SE:error setting new address.
- Failed: AT:new address could be stored temporarily only.
- Failed: RE:error reading the extended ID-code 1.

7.4 Slave Test Tool

With this function a single AS-i slave can be tested.

Please note that you must have selected the desired AS-i circuit using the arrow and the OK button when you operate a device with two AS-i circuits (see chapter 7.5.1)

```
AS-I CIRCUIT 1
AS-I CIRCUIT 2
```

Now a warning message is displayed, that possibly by this test outputs are set and the host may loose control of the circuit.

To start the test press the OK button, to cancel press the button ESC.

```
WARNING:
OUTPUTS MAY BE
SET AND HOST MAY
LOSE CONTROL
```

In the following menu the slave to be tested has to be chosen by selecting the slave address.

Afterwards the test is started by confirming the menu entry "Test".

```
SLAVE TEST TOOL
SLAVE ADR   21A
TEST
```

After finishing the test all relevant information is displayed for the tested slave. A successful test is displayed with "OK" below the address of the tested slave.

The following information are displayed:

- Address of the tested slave
- Existing errors are indicated
- Binary inputs (digital inputs), see also "Binary input", chapter 7.6.3
- Binary outputs (digital outputs), see also "Binary outputs", chapter 7.6.4
- Analog inputs, see also "Analog inputs", chapter 7.6.5
- Analog outputs, see also "Analog outputs", chapter 7.6.6
- Param (actual parameters), see also "Parameter", chapter 7.6.7
- Perm Param (projected parameters), see also "Permanent Param (projected parameter)", chapter 7.5.7
- Config (actual configuration), see also "Actual Config (actual configuration)", chapter 7.7.4
- Perm Conf (projected configuration), see also "Permanent Config (projected configuration data)", chapter 7.5.8

```
SLAVE 15 OK
BINARY INPUTS
  0 1
BINARY OUTPUTS
  0 1
ANALOG INPUTS
0 +17898
1 +32767 OVERFL
ANALOG OUTPUTS
0 +1789
1 +2500
PARAM           F
PERM PARAM      F
CONFIG          7FFE
PERM CONF       7FFE
```

7.5 Setup (configuration of AS-i circuit)

7.5.1 AS-i circuit



```
AS-I CIRCUIT 1
AS-I CIRCUIT 2
```

To reach this setup menu you have to change the desired AS-i circuit by using the arrow and the OK buttons.

The function is only implemented in the double master.

It makes possible to change the AS-i circuit that is currently active for being operated.

The active circuit is marked by the cursor.

7.5.2 Description of setup mode

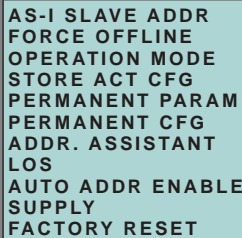

```
AS-I SLAVE ADDR
FORCE OFFLINE
OPERATION MODE
STORE ACT CFG
PERMANENT PARAM
PERMANENT CFG
ADDR. ASSISTANT
LOS
AUTO ADDR ENABLE
SUPPLY
FACTORY RESET
```

Within the menu "Setup", one of the following submenus can be chosen:

- AS-i Slave Addr (AS-i Slave Address)
- Force Offline (switch AS-i Master offline)
- Operation Mode
- Store Act Cfg (store actual detected configuration)
- Permanent Param (projected parameter)
- Permanent Cfg (projected configuration data)
- Addr. Assistant (address assistant)
- LOS (list of offline-slaves)
- Auto Adr Enable
- Supply (option by single master)
- Factory Reset (rest for the factory adjustment)

7.5.3 AS-i Slave Adr (set/change slave address)

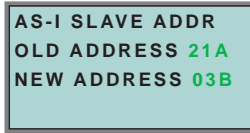

With this function the address of a slave can be changed.

To change the address select the menu entry "OLD ADDRESS" and afterwards select the address of the slave which address should be changed. The new address of the slave has to be set in the menu entry "NEW ADDRESS". The addressing is carried out by pressing the OK button.

7.5.4 Force offline

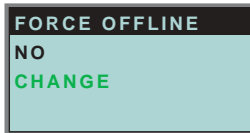

This function shows the current state of the AS-i Master:

Yes:AS-i Master is offline.

No:AS-i Master is online.

With "Change", this state can be modified.

Switching the AS-i master offline puts the AS-i circuit into the safe state. The AS-i master has to be offline if an AS-i slave should be addressed via the IR-interface.

7.5.5 Operation mode

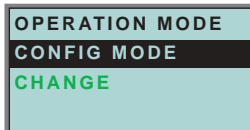

This function shows the current operation mode of the AS-i master:

Protected Mode:Protected mode

Config Mode:Configuration mode

With "Change" the operation mode can be changed.

Only in configuration mode parameters and configuration data can be stored.

7.5.6 Store Act Cfg (store actual detected configuration)

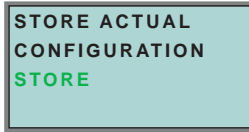

This function can only be executed in configuration mode.

This function enables you to store the configuration of all slaves which are connected and detected on the selected AS-i circuit.

If "Store" was successful, the LED "Config error" is off. The configuration is stored, the configuration error has been eliminated.

If one of the connected slaves has a peripheral fault, the LED "Config error" will flash.

If the AS-i master is in protected mode, the following error message will appear: "Failed No Config Mode"

If an AS-i slave with address zero exists, storing the configuration will be confirmed with "OK". However, the configuration error remains because address zero is not a valid operating address for storing a slave.

7.5.7 Permanent Param (projected parameter)



This function allows you to set the permanent parameters. A list of all slaves is displayed from 1A - 31A and from 1B - 31B. The permanent parameters for single slaves are set from address 1A - 31A. The parameter is shown as a hexadecimal value behind the slave address.

7.5.8 Permanent Config (projected configuration data)

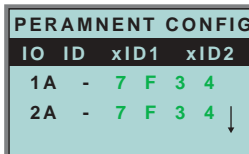

With this function the projected configuration data can be projected. The values for the configuration data are displayed behind the slave address in the following order:

IO (I/O-configuration) ID (ID-configuration) xID1 (extended ID1)
xID2 (extended ID2).

7.5.9 AS-i address assistant

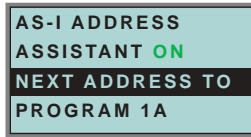

The AS-i address assistant helps you to set up the AS-i circuit quickly. Once you have stored the AS-i configuration, the AS-i address assistant addresses a new AS-i slave with address zero to the desired address.

Selecting "Assistant on" or "Assistant off" switches the AS-i address assistant on or off. The current state of the AS-i address assistant is displayed:

Assistant on: AS-i address assistant is switched on.

Assistant off: AS-i address assistant is switched off.

Procedure:

1. Store AS-i Configuration to the master. This can be done very comfortably with the Windows software AS-i-Control-Tools (Master | Write configuration to the AS-i Master ...), or directly with the fullgraphic display (see chapter 7.5.8).
2. All AS-i slaves have to be addressed to 0 or to the desired address. The slaves must be disconnected from the AS-i circuit.
3. Start the AS-i address assistant.
4. Now connect the AS-i slaves one after the other. The last line of the display of the AS-i address assistant shows which AS-i slave has to be connected next.

7.5.10 LOS (list of offline slaves)



See also "Advanced Diagnostics for AS-i Masters", chapter 8.

With "Clear all" and "Set all" you can delete or set a single bit for each AS-i slave address. Underneath there is a list of all slaves, by which the LOS bit can be set or deleted by individually selecting of the LOS bit.

Empty field: LOS bit deleted

X: LOS bit set

7.5.11 Auto Adr Enable (enable automatic address)



With this function can the programming of the automatic address be released or locked.

Meaning of the displayed mode:

Enable: Automatic address programming is released.

Disable: Automatic address programming is locked.

With "Change" the operation mode can be changed.

7.5.12 Factory reset



With this function the master can be reseted to the factory setting. The reset can be chosen by selecting the menu entry "DO RESET".

 <p>Warning</p>	<ul style="list-style-type: none">• This function should be used only in an emergency, since all attitudes transacted so far are put back to factory setting and thus perfect communication and functioning of the masters with the AS-i circle are ensured no more.• The master and the AS-i circuit have to be recommissioned and reprojected again after a successful "Reset".• In case of double masters the "Reset" acts on both AS-i masters!
---	---

7.6 IO + Param. Test

7.6.1 AS-i circuit

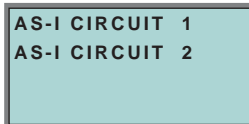

To reach this setup menu you have to change the desired AS-i circuit by using the arrow and the OK buttons.

The function is only implemented in the double master.

It makes possible to change the AS-i circuit that is currently active for being operated.

The active circuit is marked by the cursor.

7.6.2 IO + Param. Test (Testing AS-i In- and Outputs as well as reading and writing AS-i Parameters)

**WARNING
OUTPUTS MAY BE
SET AND HOST MAY
LOSE CONTROL.**

Before changing to the menu the following warning message will displayed:

"Warning: Outputs may be set and Host may lose control."

BINARY INPUTS
BINARY OUTPUTS
ANALOG INPUTS
ANALOG OUTPUTS

The menu "IO + Param.Test" enables you to choose one of the following submenus:

- Binary Inputs
- Binary Outputs
- Analog Inputs
- Analog Outputs
- Parameter

7.6.3 Binary input

BINARY INPUTS
D3...D0
1A - 0 1 0 1
2A - 0 1 0 1
3A - 0 0 0 1 ↓

This list shows the state of the binary inputs for all AS-i slaves.

0: Input deleted

1: Input set

7.6.4 Binary outputs

BINARY OUTPUTS	
D3...D0	
1A - 0 1 0 1	
2A - 0 1 0 1	
3A - 0 0 0 1	↓

This function shows the state of the binary outputs for all AS-i slaves.

- 0: Output deleted
- 1: Output set

The binary outputs can be changed after selecting the desired AS-i slave.

7.6.5 Analog inputs

ANALOG INPUTS	
1	X
2	A
3	B

This function shows the state of the analog inputs for all AS-i slaves.

The slave-types are characterized as follows:

- X** - single slave
- A** - A-slave
- B** - B-slave
- AB** - A+B slave

...

The data of the slave B start ex channel 2!

The display is as follows:

AS-i slave address, hexadecimal 16 bit value, bar display indicating the input or output value.

An eventual value overflow is displayed by "Overfl" additionally.

ANALOG IN 1	
0	+2500
1	+17898
2	+32767 OVERFL
3	-20023

7.6.6 Analog outputs

ANALOG OUTPUTS	
1	X
2	A
3	B

This function shows the state of the analog outputs for all AS-i slaves.

The display is as follows:

AS-i slave address, hexadecimal 16 bit value, bar display.

OVERFL displays any value overflows additionally.

ANALOG OUT		1
0	+2500	<div style="width: 20%; background-color: #808080; height: 10px;"></div>
1	+17898	<div style="width: 40%; background-color: #808080; height: 10px;"></div>
2	+32767 OVERFL	<div style="width: 60%; background-color: #808080; height: 10px;"></div>
3	-20023	<div style="width: 30%; background-color: #808080; height: 10px;"></div>

The analog outputs can be changed after selecting the desired AS-i slave.

7.6.7 Parameter

PARAMETER	
1	A - <u>0</u>
2	A - <u>2</u> 3A - <u>F</u>
4	A - <u>E</u> 5A - <u>3</u>

This function shows the hexadecimal value of the current AS-i parameters for all AS-i slaves.

The actual AS-i parameters can be changed after selecting the desired slave address.

7.7 Diagnosis (normal AS-i diagnosis)

7.7.1 AS-i circuit

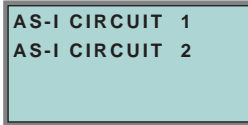

To reach this setup menu you have to change the desired AS-i circuit by using the arrow and the OK buttons.

The function is only implemented in the double master.

It makes possible to change the AS-i circuit that is currently active for being operated.

The active circuit is marked by the cursor.

7.7.2 Diagnosis (normal AS-i diagnosis)

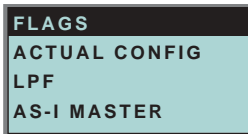

The menu "Diagnosis" enables you to choose one of the following submenus:

- Flags (EC-Flags: Execution control flags)
- Actual Config (actual configuration)
- LPF (list of periphery faults)
- AS-i Master (Info)

7.7.3 Flags

```

FLAGS:  0131 05
           0000 0001
           0011 0001
           0000 0101
1  PERIPHERY_OK
0  OFFLINE_READY
0  AS-I_PWR_FAIL
1  NORMAL_OP.
1  CONFIG_ACTIVE
0  AUTO_ADDR_AVL
0  AUTO_ADDR_ASN
0  LDS.O
1  CONFIG_OK

1  AUTO_ADDR_ENA
0  OFFLINE
1  DATA_EXCH_ACT
    
```

This function shows the EC-flags hexadecimally, binary and as single bits beginning with the lowest-order bit.

Arrangement of the bits within the byte:

Byte								
Bit value:	2 ⁷	2 ⁶	2 ⁵	2 ⁴	2 ³	2 ²	2 ¹	2 ⁰
Bit.	7	6	5	4	3	2	1	0

Byte 1:

Bit 0: Periphery_OK

This flag is set, if no AS-i slave signs a periphery fault.

Byte 2:

Bit 0:Config_OK

The flag is set, if the projected configuration corresponds with the actual configuration.

Bit 1:LDS.0

The flag is set, if an AS-i slave with address 0 has been detected.

Bit 2:Auto_Addr_Asn

The flag is set, if the automatic addressing is possible (AUTO_ADDR_ENABLE = 1; no "incorrect" AS-i slave is connected to AS-i).

Bit 3:Auto_Addr_Avl

The flag is set, if the automatic addressing is possible. This means that exactly one slave is failed.

Bit 4:Config_Active

The flag is set in the configuration mode and is reset in the protected mode.

Bit 5:Normal_Op.

The flag is set, if the AS-i master is in normal operation.

Bit 6:AS-i Pwr Fail

The flag is set, if the AS-i circuit is not sufficiently powered.

Bit 7:Offline_Ready

The flag is set, if the AS-i master is in the offline phase.

Byte 3:

Bit 0:Data_Exch_Act

If the flag "Data Exchange Active" is set, the data exchange is released with the AS-i slaves in the data exchange phase. If the bit is not set, the data exchange with AS-i slaves will be locked. Instead of data telegrams READ_ID telegrams will be sent.

The bit is set by the AS-i master by change over in the offline phase.

Bit 1:Offline

This bit is set if the operating mode offline is to be or already taken.

Bit 2:Auto_Addr_Ena

This flag indicates if the automatic addressing is locked (bit = 0) or released (bit = 1) by the user.

(See also „Get Flags (GET_FLAGS)“, page 87)

7.7.4 Actual Config (actual configuration)

ACTUAL CONFIG		
0A	I	1A-Cf
2Ax	I	3Ad
4p	I	5A
		↓

This function shows the state of the actual configuration of the individual AS-i slaves.

At the end of the list there is a help text describing the abbreviations:

X (O.K.):The configuration data of the detected AS-i slave matches the projected configuration data.

D (Detected Only):An AS-i slave is detected at this address, but not projected.

P (Projected Only):An AS-i slave is projected at this address, but not detected.

C (Type Conflict):The configuration data of the detected AS-i slave does not match the projected configuration data. The actual detected configuration of the connected AS-i slave is displayed.

F (Periph. Fault):The AS-i slave has a peripheral fault.

A (Duplicate Adr.):2 AS-i slaves in the indicated address

After selecting the desired AS-i slave address the values for the actual configuration data are displayed behind the respective address in the following order:

IO (I/O-configuration) ID (ID-configuration) xID1 (extended ID1)

xID2 (extended ID2)

0A - -
1A - 7A28 - C
TYPE CONFLICT

Furthermore the state of the configuration is displayed in plain text.

If no AS-i slave is detected and no AS-i slave is projected at a certain address, four dots instead of the configuration data are displayed.

7.7.5 LPF (List of periphery faults)

LPF LIST OF PERIPH. FAULTS		
	I	1A-x
2A-	I	3A-
		↓

The list shows AS-i slaves, which have released a peripheral fault.

Empty field: Periphery O.K.

X: Periphery fault

7.7.6 AS-i master (info)



This function shows information about the version and the features of the AS-i master.

Version xxxxxxxx (date of the firmware)

Feature String xxxxxxxxxxxxxxxx

7.8 Adv. Diagnosis (advanced AS-i diagnosis)

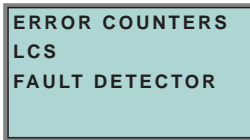

See also "Advanced Diagnostics for AS-i Masters", chapter 8.

In the menu "Adv. Diagnosis", the following submenus can be found:

- Error Counters
- LCS (list of slaves, that produced a configuration error)
- Fault Detector

7.8.1 Error counters

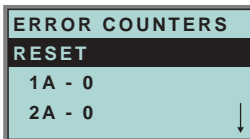

This list shows the error counter for each single AS-i slave.

Furthermore the number of power failures on AS-i (APF) is displayed.

By selecting "Reset", the error counters are reset to 0.

7.8.2 LCS (list of slaves having caused a configuration error)

RESET		
APF-	I	1A-x ↑
2A-	I	3A-
4A-x	I	5A ↓

This list shows for each single AS-i slave whether at least one configuration error was caused by an enormous telegram transmission. This function is especially important if the configuration error only occurs short-time.

Empty field: No error

X: AS-i slave caused a configuration error.

7.8.3 Fault detector

FAULT DETECTOR
RESET
HISTORIC:
EFLT OVRV NOIS
ACTUAL:
EFLT OVRV NOIS
DUP ASI ADR:
0 I 31B
HELP:
EFLT EARTH FAULT
OVRV OVERVOLATAGE
NOIS NOISE
DUP ASI ADR
DUPLICATE ASI
SLAVE ADDRESS

The menu "Fault Detector" shows information about the AS-i detector and allows deleting of the AS-i detector's history. Furthermore a list of abbreviations in plain language can be found in the section "Help".

By selecting "Reset" the history of the AS-i detector can be deleted.

In the section "Historic" the appeared error messages of the AS-i detector are listed since the last "Reset".

In the section "Actual" the actual appeared error messages of the AS-i detector are listed.

Following error messages are possible:

- Duplicate address (the 2 lowest slave addresses are displayed, at which a duplicate address exist).
- Earth faults
- Noise
- Overvoltage

7.9 AS-i safety



This function shows information about the safety slaves and the safety monitor:

- Safety Slaves
- Safety Monitor
- Safety Substitute Value

7.9.1 Safety slaves (safety oriented slaves)



This list shows the "safety-directed input slaves" ("AS-i Safety at Work"), by which the safety function is released.

X:channel o.k.
R:channel has released

The first area corresponds with the channel 2, the second one with the channel 1. XR means also: channel 2 is OK and channel 2 has released.

The channels can not be evaluate individually, if the substitution of safety slaves input data was disconnected in menu:

- command interface/ function profile

or

- slave value substitute.

Both channels must have the same state, otherwise the indication will not be proper.

7.9.2 Safety monitor

SAFETY MONITOR DIAGNOSIS	
ADDR:	17
MODE:	SORTED/V1
STATUS:	O.K.
CH.1:	OFF
CH.2:	OFF
1-32:	GREEN
...	

The AS-i safety monitor reads the diagnosis data of the AS-i safety monitor and shows on the display. The meaning of the shown diagnosis can be seen in the description of the safety monitor.

7.9.3 Safety Subst Value

SAFETY SUBST VAL SUBSTITUTE CHANGE
--

With this function the input-data-substitution by safety slaves can be turn off/on.
SUBSTITUTE

The input-data are replaced mit following values:

Both channels released: 0000bin

Channel 1 released: 0011bin

Channel 2 released: 1100bin

No channel has released: 1111bin

NO SUBSTITUTE

The safety slave input data are shown unmodified.

7.10 Display contrast

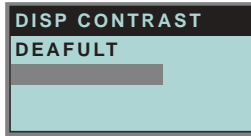

With this function display contrast can be adjusted.

Factory adjustment will be reloaded by selecting DEAFULT.

Approach to set the display contrast:

- select the bar line with soft keys
- verify with *OK* (the bar line flashes)
- set the display contrast with soft keys
- assume with *OK*.

If the contrast is completely misaligned, set it as follows:

- turn the master off
- press the buttons *MODE* + *SET* and hold them
- turn the master on.

7.11 Language of displayed messages

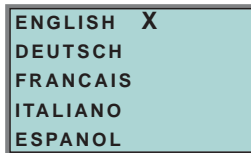

The list of **messages** (like "missing slave" or "unknown slave") shown on the screen can be edited in the one of the listed languages by using the softkey + *OK* buttons. The current language is marked with "x".



Note

The menu-language is English. This attitude cannot be changed! It is only possible to change the language of displayed messages (like "missing slave" or "unknown slave").

8 Advanced Diagnostics for AS-i Masters

The advanced AS-i diagnostics serve to locate occasionally occurring errors and to judge the quality of data transmission on AS-i without additional diagnostics tools.

AS-i Control Tools (software for comfortable commissioning of AS-i and programming of AS-i Control) supports the operation of the advanced diagnostics (LCS, error counters and LOS).

8.1 List of corrupted AS-i Slaves (LCS)

The *LCS* contains the history of the delta list. Besides the list of projected slaves (*LPS*), the list of detected slaves (*LDS*) and the list of activated slaves (*LAS*), a fourth list, the **list of corrupted slaves (LCS)**, is created by AS-i masters with advanced diagnostics in order to locate occasionally occurring short-time configuration errors. This list contains entries of all AS-i slaves which were responsible for at least one configuration error since powering up the AS-i master or reading the list. Short-time AS-i power failures are listed in the *LCS* at the position of AS-i slave with address 0.

 Note	With every read-access the LCS will be deleted.
---	---

 Note	<p>The last short-time configuration error can also be displayed on the AS-i master:</p> <ul style="list-style-type: none"> • Pressing the "Set" button of the AS-i master shows the AS-i slave which was responsible for the last short-time configuration error. If there was a short-time AS-i power failure the display shows "39" after pressing the "Set" button. • This function is only available if the device is in the normal operation mode of the protected mode (display empty) or in the off-line-phase.
---	---

8.2 Protocol analysis: counters of corrupted data telegrams

The AS-i master with advanced diagnostics has a counter of telegram repetitions for each AS-i slave, which count up every time a corrupted data telegram has been found. This makes possible to judge the quality of the AS-i network, even if only a few corrupted telegrams occurred and the AS-i slave did not cause any configuration errors.

 Note	<ul style="list-style-type: none"> • The counter values can be read via the host interface and will be deleted with every read access. • The counter value is limited to 254. 255 will cause a counter overflow.
---	--

The protocol analysis is included in the software **AS-i Control Tools** (by using the command *Master | AS-i Diagnostics*).

Issue date - 24.8.2007

8.3 Offline phase on configuration errors (LOS)

The AS-i masters with advanced diagnostics offer the possibility to put themselves into the offline phase when a configuration error on the AS-Interface occurs. This way the security of the application can be ensured. The reaction to a configuration error is very fast and the host can be relieved from this task. If there are any problems on the AS-i network, the AS-i can be switched to a secure state.

There are two different ways to parameterize the AS-i master for this feature:

- Every configuration error during normal operation in protected mode releases the off-line phase.
- For each slave address, it can be chosen whether a configuration error on this address will cause the offline phase or not. This information is stored in the list of offline slaves (LOS).

The user himself can decide how the system reacts to a configuration error on the AS-i. The AS-i master can release the off-line phase in critical situations, i. e. only with certain slave addresses, whereas in less critical situations (if one of the other AS-i slaves has a configuration error) only the error message is sent to the host, but AS-i is still running.

The parameterization "off-line phase on configuration error" is also supported by the "AS-i-Control-Tools" (command Master | Identity | Offline on configuration error).

Two ways to reset the error message "OFFLINE BY LOS" are possible:

1. Deleting of the complete list LOS of the affected AS-i circuit ("CLEAR ALL").
2. Voltage reset at the affected AS-i circuit.

 <p>Attention</p>	<p>By voltage reset at the AS-i circuit 1 the complete double gateway will be shut down.</p>
--	--

8.4 Functions of the AS-i fault detector

8.4.1 Duplicate address' recognition

If two slaves have the same address in an AS-i circuit, a duplicate address exists. Because of this error the master can not send a request to each slave separately. At that time both responses overlap themselves on the line, it is impossible for the master to recognize the slave response safely. It exists an unstable network behaviour.

The function "duplicate address' recognition" allows to recognize a duplicate address and to indicate this both via superior fieldbus and in the AS-i Control Tools.

A duplicate address causes a configuration error und will be shown in the display of the master.

 Note	<p>Duplicate addresses can be recognized only in the AS-i segment directly at the master. If both slaves participate in a duplicate address located behind a repeater, the <i>duplicate address' recognition</i> is impossible.</p>
--	---

8.4.2 Earth fault detector

An *Earth Fault* exists when the voltage U_{GND} (Nominal value of $U_{\text{GND}}=0,5 U_{\text{AS-i}}$) is outside of the following range:

$$10\% U_{\text{AS-i}} \leq U_{\text{GND}} \leq 90\% U_{\text{AS-i}}$$

This error limits the fail-safe characteristic of the AS-i transmission substantially. Earth faults are indicated in the master's display and AS-i Control Tools.

 Note	<p>By a double master in version 1 power supply for 2 AS-i circuits an earth fault in one of the both circuits causes also an earth fault in the other circuit because of the existing galvanic connection.</p>
--	---

 Note	<p>For recognition of earth faults the master must be grounded with the function earth.</p>
--	---

8.4.3 Noise detector

The noise detector detects alternating voltages on AS-i, which are not produced by AS-i master or AS-i slaves. These interference voltages can cause telegram disturbances.

A frequent cause are insufficiently shielded frequency inverters or awkwardly shifted cables.

Noises are indicated in the master's display and the AS-i Control Tools.

8.4.4 Overvoltage detector

Overvoltages are present, if the AS-i line, whose conductors lie normally electrically symmetrically to the plant earth, are strongly electrically raised. A cause can be e.g. power-on procedures of large consumers. However sometimes overvoltages don't generally disturb AS-i communication, but can release incorrect signals of sensors.

Overvoltages are indicated in the master's display and the AS-i Control Tools.

9 PROFIBUS DP

This chapter contains all necessary information to operate the AS-i/PROFIBUS gateways in a PROFIBUS DP network.



Note

The respective bits **ground fault**, **overvoltage**, **noise**, **double address** will only be set if AS-i masters are used, which also support these functions.

9.1 DP Telegrams

9.1.1 Diagnosis

DP Diagnosis - Single Master					
PDU byte	user byte		DP	DP V1	user
1	–	station_status 1	4		
2	–	station_status 2	4		
3	–	station_status 3	4		
4	–	master address	4		
5	–	ident high	4		
6	–	ident low	4		
7	1	header	4	4	
8	2	type		4	
9	3	slot		4	
10	4	spec		4	
11	5	ec-flags (high)			4
12	6	ec-flags (low)			4
13	7	delta (0...7)			4
14	8	delta (8...15)			4
...
20	14	delta (56...63)			4
21	15	LPF (0...7)			4
...
28	22	LPF (56 ... 63)			4

DP Diagnosis - Double Master					
PDU byte	user byte		DP	DP V1	user
1	–	station_status 1	4		
2	–	station_status 2	4		
3	–	station_status 3	4		
4	–	master address	4		
5	–	ident high	4		
6	–	ident low	4		
7	1	header	4	4	
8	2	type		4	
9	3	slot		4	
10	4	spec		4	
11	5	ec-flags (high), circuit 1			4
12	6	ec-flags (low), circuit 1			4
13	7	delta (0...7), circuit 1			4
14	8	delta (8...15), circuit 1			4

Issue date - 24.8.2007

DP Diagnosis - Double Master					
PDU byte	user byte		DP	DP V1	user
...
20	14	delta (56...63), circuit 1			4
21	15	LPF (0...7), circuit 1			4
...
28	22	LPF (56 ... 63), circuit 1			4
29	23	reserved			4
...
36	30	reserved			4
37	31	ec-flags (high), circuit 2			4
38	32	ec-flags (low), circuit 2			4
39	33	delta (0...7), circuit 2			4
40	34	delta (8...15), circuit 2			4
...
46	40	delta (56...63), circuit 2			4
47	41	LPF (0...7), circuit 2			4
...
54	48	LPF (56 ... 63), circuit 2			4

ec-flags (high):

- Bit 0:periphery fault
- Bit 1 ... Bit 2reserved
- Bit 3:failure redundant 24 V
- Bit 4:earth fault
- Bit 5:over voltage
- Bit 6:noise
- Bit 7:duplicate address

ec-flags (low):

- Bit 0:configuration error
- Bit 1:slave with address0 detected
- Bit 2:Auto_address_assignment not possible
- Bit 3:Auto_address_assingment available
- Bit 5:not in normal operation
- Bit 4:configuration mode actice
- Bit 6:AS-i power fail
- Bit 7:AS-i master is offline

Delta List: List of AS-i slaves with configuration error.

- 1:ConfigError
- 0:no ConfigError

LPF: List of AS-i slaves with periphery fault.

- 1:periphery fault
- 0:no periphery fault

Each element of the user diagnosis (ec-flags and slave lists) can be switched off by setting the appropriate bit in the parameter telegram.

Each element which is not used will be filled up with zeroes. This way the data elements in the diagnosis telegram will keep its designated position (and clear text diagnosis still fits to the data).

Only if an element at the end of the user diagnosis is not used, the length of the diagnosis will be shortened.

ExtDiag will be set if at least one of the following conditions is fulfilled:

- ConfigError \equiv 1
- APF \equiv 1
- PeripheryFault \equiv 1

The conditions when to set the ExtDiag bit can be chosen using the user parameters or the commands of the command interface.

The GSD file includes the following presettings:

- The diagnosis transmits ec-flags, delta list and LPF.
- ExtDiag will be set if ConfigError = 1 and APF = 1. ExtDiag will not be set if there is a periphery fault.

If a double master is being used, the User-Diagnosis-Bytes 5 to 30 represent AS-i network 1 and the User-diagnosis bytes 31 to 56 represent AS-i network 2.

9.1.1.1 Parameters

With the user parameters you can choose if and which slave list will be displayed in the diagnosis. Furthermore you can select which conditions have to be fulfilled to set the ExtDiag bit within the diagnosis telegram.

DP Parameters - Single Master						
PDU byte	user byte		DP	DP V1	user	default
1	–	Station_Status	4			
2	–	WD_Fact_1	4			
3	–	WD_Fact_2	4			
4	–	min T _{sdr}	4			
5	–	Ident High	4			
6	–	Ident Low	4			
7	–	Group_Ident	4			
8	1	DPV Status 1		4		80 ₁₆
9	2	DPV Status 2		4		00 ₁₆
10	3	DPV Status 3		4		00 ₁₆
11	4	User Byte 1			4	0B ₁₆
12	5	User Byte 2			4	06 ₁₆
13	6	User Byte 3			4	00 ₁₆

DP Parameters - Double Master						
PDU byte	user byte		DP	DP V1	user	default
1	–	Station_Status	4			
2	–	WD_Fact_1	4			
3	–	WD_Fact_2	4			
4	–	min T _{sdr}	4			
5	–	Ident High	4			
6	–	Ident Low	4			
7	–	Group_Ident	4			
8	1	DPV Status 1		4		80 ₁₆
9	2	DPV Status 2		4		00 ₁₆
10	3	DPV Status 3		4		00 ₁₆
11	4	User Byte 1, circuit 1			4	0B ₁₆
12	5	User Byte 2, circuit 1			4	06 ₁₆
13	6	User Byte 3, circuit 1			4	00 ₁₆
14	7	User Byte 1, circuit 2			4	0B ₁₆
15	8	User Byte 2, circuit 2			4	06 ₁₆

DP Parameters - Double Master						
PDU byte	user byte		DP	DP V1	user	default
16	9	User Byte 3, circuit 2			4	00 ₁₆

The bits in "User Byte 1" and "User Byte 3" have the following meanings:

User Byte 1								
	2 ⁷	2 ⁶	2 ⁵	2 ⁴	2 ³	2 ²	2 ¹	2 ⁰
	-	-			LPF	-	D	F
default	0	0	0	1	0	1	1	

User Byte 2								
	2 ⁷	2 ⁶	2 ⁵	2 ⁴	2 ³	2 ²	2 ¹	2 ⁰
	FD	0	CS	PF	APF	CF	-	
default	0	0	0	0	1	1	0	

User Byte 3								
	2 ⁷	2 ⁶	2 ⁵	2 ⁴	2 ³	2 ²	2 ¹	2 ⁰
	-				0			
default	0				0			

- LPF: 1: LPF will be transmitted in the diagnosis
0: LPF will not be transmitted
- D: 1: Delta list will be transmitted in the diagnosis
0: Delta list will not be transmitted
- F: 1: EC-flags will be transmitted in the diagnosis
0: EC-flags will not be transmitted
- FD: If this bit is set, the PROFIBUS diagnosis is refreshed only if the PROFIBUS norm dictates this ("freeze diagnosis"). In doubt the data of the PROFIBUS masters diagnosis are not up to date.
- CS: 1: ExtDiag will be set if the LCS is not empty
0: ExtDiag will not be set if the LCS is not empty
- PF: 1: ExtDiag will be set if there is a periphery fault at the AS-i line
0: ExtDiag will not be set.
- APF: 1: ExtDiag will be set if there is an AS-i Power Fail
0: ExtDiag will not be set.
- CF: 1: ExtDiag will be set if there is a configuration error
0: ExtDiag will not be set.

The GSD's default user parameter telegram is:

80 ₁₆	00 ₁₆	00 ₁₆	0B ₁₆	06 ₁₆	00 ₁₆
------------------	------------------	------------------	------------------	------------------	------------------

(DPV1 enabled, diagnosis settings according to chapter 9.1.1)

If a double master is being used, the data for AS-i circuit are transmitted in the user parameter bytes 4 to 6. For circuit 2 3 additional bytes are added.

9.1.2 Configuration DP V0 (cyclic data)

The configuration of the AS-i/PROFIBUS gateways is made with the GSD file. Therefore the provided GSD file has to be imported into your PROFIBUS configuration tool.

9.1.2.1 Options

The original data input and outlet data can be used with different „Special IDs“.

The advantages of special input and output IDs are, that they can include up to 64 elements (bytes or words), and that the length of input and output data can be different. Additionally, "manufacturer specific" data bytes describing the ID type are possible. These "manuafaturer specific" data bytes describe the which type ID is.

The GSD file offers here several combinations (several lengths) for transmitting I/O data, command interface (management) and analog data.

Therefore the analog data can be transmitted directly in the process data channel and do not have to be requested by the slower DP V1 commands.

Maximally 8 modules can be configured.

The detailed possibilities:

Length	Description
4 bytes	digital input (slaves 0 - 7)
8 bytes	digital input (slaves 0 - 15)
12 bytes	digital input (slaves 0 - 23)
16 bytes	digital input (slaves 0 - 31)
20 bytes	digital input (slaves 0 - 7B)
24 bytes	digital input (slaves 0 - 15B)
28 bytes	digital input (slaves 0 - 23B)
32 bytes	digital input (slaves 0 - 31B)

Length	Description
4 bytes	digital output (slaves 0 - 7)
8 bytes	digital output (slaves 0 - 15)
12 bytes	digital output (slaves 0 - 23)
16 bytes	digital output (slaves 0 - 31)
20 bytes	digital output (slaves 0 - 7B)
24 bytes	digital output (slaves 0 - 15B)
28 bytes	digital output (slaves 0 - 23B)
32 bytes	digital output (slaves 0 - 31B)

Length	Description
16 bytes	digital in/out (slaves 0 - 31)
16 Bytes	digital in/out (slaves 0B - 31B)
32 bytes	digital in/out (slaves 0 - 31B)

Issue date - 24.8.2007



Note

2 command interfaces can be intergrated.

Length	Description
2 bytes	management (command interface)
4 bytes	management (command interface)
8 bytes	management (command interface)
11 bytes	management (command interface)
12 bytes	management (command interface)
34 bytes	management (command interface)
36 bytes	management (command interface)

Length	Description
24 bytes	analog input (slaves 29 - 31)
56 bytes	analog input (slaves 25 - 31)
88 bytes	analog input (slaves 21 - 31)
120 bytes	analog input (slaves 17 - 31)
128 bytes	analog input (slaves 16 - 31)
16 bytes	analog input (slaves 14 - 15)

Length	Description
24 bytes	analog output (slaves 29 - 31)
56 bytes	analog output (slaves 25 - 31)
88 bytes	analog output (slaves 21 - 31)
120 bytes	analog output (slaves 17 - 31)
128 bytes	analog output (slaves 16 - 31)
16 bytes	analog output (slaves 14 - 15)

Length	Description
2 bytes ... 128 bytes	analog input data circuit 1, dynamic ¹
2 bytes ... 128 bytes	analog output data circuit 1, dynamic ¹
2 bytes ... 128 bytes	analog input data circuit 2, dynamic ¹
2 bytes ... 128 bytes	analog output data circuit 2, dynamic ¹

1. Module parameters necessarily

Length	Description
2 bytes	flags and AS-i detector circuit 1
2 bytes	flags and AS-i detector circuit 2

Issue date - 24.8.2007

9.1.3 I/O Data

9.1.3.1 Process data

In V2.1 mode the AS-i I/O data are mapped in the process data as known from the Siemens and AS-i/InterBus masters. This means that the lower nibble describes the data of the AS-i slave with the higher slave address. The ec-flags or hi-flags are additionally mapped at the nibble of AS-i slave 0.

byte	2 ⁷	2 ⁶	2 ⁵	2 ⁴	2 ³	2 ²	2 ¹	2 ⁰
0	flags				slave 1/1A			
	F3	F2	F1	F0	D3	D2	D1	D0
1	slave 2/2A				slave 3/3A			
2	slave 4/4A				slave 5/5A			
3	slave 6/6A				slave 7/7A			
4	slave 8/8A				slave 9/9A			
5	slave 10/10A				slave 11/11A			
6	slave 12/12A				slave 13/13A			
7	slave 14/14A				slave 15/15A			
8	slave 16/16A				slave 17/17A			
9	slave 18/18A				slave 19/19A			
10	slave 20/20A				slave 21/21A			
11	slave 22/22A				slave 23/23A			
12	slave 24/24A				slave 25/25A			
13	slave 26/26A				slave 27/27A			
14	slave 28/28A				slave 29/29A			
15	slave 30/30A				slave 31/31A			
16	reserved				slave 1B			
17	slave 2B				slave 3B			
18	slave 4B				slave 5B			
19	slave 6B				slave 7B			
20	slave 8B				slave 9B			
21	slave 10B				slave 11B			
22	slave 12B				slave 13B			
23	slave 14B				slave 15B			
24	slave 16B				slave 17B			
25	slave 18B				slave 19B			
26	slave 20B				slave 21B			
27	slave 22B				slave 23B			
28	slave 24B				slave 25B			
29	slave 26B				slave 27B			
30	slave 28B				slave 29B			
31	slave 30B				slave 31B			

Issue date - 24.8.2007

Flags		
	input data	output data
F0	ConfigError	Offline
F1	APF	LOS master bit
F2	PeripheryFault	→ ConfigurationMode
F3	ConfigurationActive	→ ProtectedMode

ConfigError: 0 = ConfigOK, 1 = ConfigError
 APF: 0 = AS-i Power OK, 1 = AS-i Power Fail
 PeripheryFault: 0 = PeripheryOK, 1 = PeripheryFault
 ConfigurationActive: 0 = ConfigurationActive, 1 = ConfigurationInactive
 Offline: 0 = Online, 1 = Offline
 LOS-Master-Bit 0 = Offline by ConfigError deactivated
 1 = Offline by ConfigError activated

A rising edge of F2 and F3 switch the master to the desired mode.

A rising edge of the "LOS master bit" effects that all bits in the LOS are set. A falling edge effects that all bits are deleted.

9.1.3.2 EC-Flags and AS-i watchdog

In addition to EC flags, the AS-i watchdog flags will be transferred in diagnostic data too.

Diagnostic data are assembled as follows:

ec-flags (high):

Bit 0: periphery fault
 Bit 1 ... Bit 2 reserved
 Bit 3: failure redundant 24 V (option single master)
 Bit 4: earth fault
 Bit 5: over voltage
 Bit 6: noise
 Bit 7: duplicate address

ec-flags (low):

Bit 0: configuration error
 Bit 1: slave with address0 detected
 Bit 2: Auto_address_assignment not possible
 Bit 3: Auto_address_assignment available
 Bit 4: configuration mode actice
 Bit 5: not in normal operation

9.1.3.3 AS-i 16-bit data

 Note	<p>A-Slaves map the data on channels 1 and 2. B-Slaves map the data on channels 3 and 4.</p>
--	---

In addition to the access via the command interfaces, the 16-bit data for or by the slaves with 16-bit value can be exchanged cyclically (profile 7.3., S-7.4, S-6.0, S-7.5, S-7.A.8, S-7.A.9, S-7.A.A). Competing writing access attempts on analog output data will not be blocked by each other. If analog data for a particular slave are being transmitted both cyclically and acyclically with the command interface or via DP V1 connections, the acyclically transmitted values will be overwritten by the cyclically transmitted values.

AS-i 16-bit data can be transmitted in a reserved data area. Therefore accessing analog data is as easy as accessing digital data.

AS-i 16-bit data								
byte	2^7	2^6	2^5	2^4	2^3	2^2	2^1	2^0
1	slave 31-n/8, channel 1, high byte							
2	slave 31-n/8, channel 1, low byte							
3	slave 31-n/8, channel 2, high byte							
4	slave 31-n/8, channel 2, low byte							
...	...							
n-3	slave 31, channel 3/slave 31B, channel 1, high byte							
n-2	slave 31, channel 3/slave 31B, channel 1, low byte							
n-1	slave 31, channel 4/slave 31B, channel 2, high byte							
n	slave 31, channel 4/slave 31B, channel 2, low byte							

9.1.3.4 Command Interface

Only using the IDs of the process data field the AS-i/PROFIBUS gateway can be used as M0 AS-i master. By using the command interface (see chapter 9.1.3) the functions of a M3 master become available.

Request								
byte	2^7	2^6	2^5	2^4	2^3	2^2	2^1	2^0
1	command							
2	T	circuit						
3	request parameter byte 1							
...	...							
36	request parameter byte 34							

Issue date - 24.8.2007

Answer								
byte	2^7	2^6	2^5	2^4	2^3	2^2	2^1	2^0
1	command (mirrored)							
2	result							
3	response parameter byte 1							
...	...							
34	response parameter byte 32							

A command of the command interface will be edited if the toggle bit T has changed. This way the same command can be used repeatedly.

The commands of the command interface can also be activated with PROFIBUS DP V1. Even the process data exchange is possible via the command interface. This way the Windows configuration software "AS-i Control Tools" can run the whole communication via DP V1.

9.2 DP V1

To exchange data between the PROFIBUS master and the AS-i/PROFIBUS gateway via PROFIBUS DP V1 only one data block is used - slot 1, index 16. Within this data block a command interface is installed like the one used in the DP telegram.

The DP V1-command interfaces are edited every time they are sent. Therefore it is possible to execute the same command several times without changing "command" or "circuit" and setting a toggle bit.

9.3 Restrictions

The SPC3 has only 1,5 KByte DP-RAM available. Therefore the lengths of telegrams and the numbers of DP V1-connections to class 2 masters have to be restricted.

Restrictions due to the SPC3		
MSC1	input/output data	single master: 288 bytes ¹ double master: 272 bytes ²
	diagnosis	62 bytes
	parameters	single master: 53 bytes double master: 88 bytes
	configuration ³	32 bytes
	SetSlaveAddress	4 bytes
MSAC1	SAPs PDU	1 72 bytes ⁴
MSAC2	SAPs PDU	2 72 bytes ⁵

1. The maximum length of the input and output data can vary up to 288 bytes input or output data if the **I+M** (information+maintenance) **service** is *on* only. The maximum length of the input and output data (both master) is not variable and it is limited to 144 bytes (for input and output data) if the **I+M service** is disabled.
2. The maximum length of the input and output data can vary up to 272 bytes input or output data if the **I+M** (information+maintenance) **service** is *on* only. The maximum length of the input and output data (both master) is not variable and it is limited to 144 bytes (for input and output data) if the **I+M service** is disabled.
3. Maximally 8 modules can be configured
4. The maximum length is limited to 42 bytes if the **I+M service** is *off*.
5. The maximum length is limited to 52 bytes if the **I+M service** is *off*.

10 Command Interface

10.1 Construction

Command interface call-instructions are described as follows:

Request								
byte	2^7	2^6	2^5	2^4	2^3	2^2	2^1	2^0
1	command							
2	T	–	circuit					
3	request parameter byte 1							
...	...							
36	request parameter byte 34							

Response								
byte	2^7	2^6	2^5	2^4	2^3	2^2	2^1	2^0
1	command							
2	T	result						
3	response parameter byte 1							
...	...							
36	response parameter byte 34							

Command byte and T-bit are always part of the response. The T-bit is necessary to operate the command interface via a MSC1 connection (PROFIBUS DP V0) This way the same command of the command interface can be used two times repeatedly, possibly with different parameters.

The execution of a command of the command interface is declined, if the number of the transferred parameters is too small which means that the command interface in the cyclic channel is too small or the DP V1-telegram is too short.

The commands of the command interface are valid as well for PROFIBUS DP V0 as for PROFIBUS DP V1.

Circuit = 0 If an AS-i gateway with one AS-i master or the master 1 of an AS-i gateway with 2 masters should be chosen.

Circuit = 1 If master 2 of an AS-i gateway with 2 masters should be chosen.

The commands for reading and writing exist in two variations. At the first variation the bits in the slave lists are arranged as usually with Pepperl+Fuchs products: Data for slave with lower address appear in the lower bits. The second variation is compatible to Siemens masters: The sequence of the bits in the slave lists bytes are inverse.

Switching between the two variations can be done with bit 2^6 in byte 2 of the request. If it is deleted, the Pepperl+Fuchs arrangement is selected, otherwise the Siemens compatible arrangement is selected.

The coding of requests for commands to reading and writing is following therefore:

Request								
byte	2 ⁷	2 ⁶	2 ⁵	2 ⁴	2 ³	2 ²	2 ¹	2 ⁰
1	command							
2	T	0	circuit					
3	Request parameter byte 1							
...	...							

10.2 List of all commands

Values for command

see page	Command	Value	Meaning	Req Len	Res Len
page 74	AS-i 16-bit data				
page 75	RD_7X_IN	50 ₁₆	Read 1 16-bit slave profile in.data	3	10
page 75	WR_7X_OUT	51 ₁₆	Write 1 16-bit slave profile out.data	11	2
page 76	RD_7X_OUT	52 ₁₆	Read 1 16-bit slave profile out.data	3	10
page 76	RD_7X_IN_X	53 ₁₆	Read 4 16-bit slave profile in.data	3	34
page 77	WR_7X_OUT_X	54 ₁₆	Write 4 16-bit slave profile out.data	35	2
page 77	RD_7X_OUT_X	55 ₁₆	Read 4 16-bit slave profile out.data	3	34
page 78	OP_RD_16BIT_IN_CX	4C ₁₆	Read 16 channels 16-bit slave in.data	3	34
page 78	OP_WR_16BIT_IN_CX	4D ₁₆	Write 16 channels 16-bit slave in.data	36	2
page 79	Commands acc. to Profile S-7.4/S-7.5				
page 79	WR_74_75_PARAM	5A ₁₆	Write S-7.4/S-7.5-slave parameter	≥6	2
page 80	RD_74_75_PARAM	5B ₁₆	Read S-7.4/S-7.5-slave parameter	4	≥3
page 81	RD_74_75_ID	5C ₁₆	Read S-7.4/S-7.5-slave ID string	4	≥3
page 81	RD_74_DIAG	5D ₁₆	Read S-7.4/S-7.5-slave diagnosis string	4	≥3
page 82	Acyclic commands				
page 82	WRITE_ACYC_TRANS	4E ₁₆	Write acyclic transfer	≥7	2
page 84	READ_ACYC_TRANS	4F ₁₆	Read acyclic transfer	5	≥2
page 85	AS-i Diagnosis				
page 85	GET_LISTS	30 ₁₆	Get LDS, LAS, LPS, Flags	2	29
page 87	GET_FLAGS	47 ₁₆	Get_Flags	2	5
page 88	GET_DELTA	57 ₁₆	Get list of config. diff.	2	10
page 89	GET_LCS	60 ₁₆	Get LCS	2	10
page 89	GET_LAS	45 ₁₆	Get_LAS	2	10
page 90	GET_LDS	46 ₁₆	Get_LDS	2	10
page 91	GET_LPF	3E ₁₆	Get_LPF	2	10
page 91	GET_LOS	61 ₁₆	GET_LOS	2	10
page 92	SET_LOS	62 ₁₆	SET_LOS	10	2
page 93	GET_TECA	63 ₁₆	Get transm.err.counters	2	34
page 94	GET_TECB	64 ₁₆	Get transm.err.counters	2	34
page 94	GET_TEC_X	66 ₁₆	Get transm.err.counters	4	≥3
page 95	READ_FAULT_DETECTOR	10 ₁₆	Read Fault Detector	2	4
page 96	READ_DUPLICATE_ADDR	11 ₁₆	Read List of Duplicate Addresses	2	10
page 97	Configuration of AS-i Master				
page 97	SET_OP_MODE	0C ₁₆	Set_Operation_Mode	3	2
page 98	STORE_CDI	07 ₁₆	Store_Actual_Configuration	2	2

Issue date - 24.8.2007

Values for command

see page	Command	Value	Meaning	Req Len	Res Len
page 98	READ_CDI	28 ₁₆	Read_Actual_Configuration	3	4
page 99	SET_PCD	25 ₁₆	Set_Permanent_Config	5	2
page 99	GET_PCD	26 ₁₆	Get_Permanent_Config	3	4
page 100	SET_LPS	29 ₁₆	SET_LPS	11	2
page 101	GET_LPS	44 ₁₆	Get_LPS	2	10
page 102	STORE_PI	04 ₁₆	Store_Actual_Parameter	2	2
page 102	WRITE_P	02 ₁₆	Write_Parameter	4	3
page 103	READ_PI	03 ₁₆	Read_Parameter	3	3
page 103	SET_PP	43 ₁₆	Set_Permanent_Parameter	4	2
page 104	GET_PP	01 ₁₆	Get_Permanent_Parameter	3	3
page 104	SET_AAE	0B ₁₆	Set_Auto_Address_Enable	3	2
page 107	SLAVE_ADDR	0D ₁₆	Change_Slave_Address	4	2
page 106	WRITE_XID1	3F ₁₆	Write_Extended_ID-Code_1	3	2
page 106	Other commands				
page 107	IDLE	00 ₁₆	No request	2	2
page 108	READ_IDI	41 ₁₆	Read IDI	2	36
page 109	WRITE_ODI	42 ₁₆	Write ODI	34	2
page 109	READ_ODI	56 ₁₆	Read ODI	2	34
page 110	SET_OFFLINE	0A ₁₆	Set_Off-Line_Mode	3	2
page 111	SET_DATA_EX	48 ₁₆	Set_Data_Exchange_Active	3	2
page 111	BUTTONS	75 ₁₆	Disable Pushbuttons	3	2
page 111	FP_PARAM	7D ₁₆	„Functional Profile“ Parameter	≥3	≥2
page 125	function 0E ₁₆	0E ₁₆	set display language	4	3
page 126	function 0F ₁₆	0F ₁₆	set safety input slave "interpretation data"	4	2
page 112	FP_DATA	7E ₁₆	„Functional Profile“ Data	≥3	≥2
page 116	function 00 ₁₆	00 ₁₆	slaves with released safety function, response contains EcFlags	3	8
page 117	function 0D ₁₆	0D ₁₆	slaves with released safety function, response doesn't contain EcFlags	3	6
page 118	function 02 ₁₆	02 ₁₆	"Safety at Work" monitor diagnosis	5	n
page 124	function 03 ₁₆	03 ₁₆	integrated AS-i sensors: Warnings	3	10
page 125	function 04 ₁₆	04 ₁₆	integrated AS-i sensors: Availability	3	6
page 126	function 0E ₁₆	0E ₁₆	read display language	3	3
page 127	function 0F ₁₆	0F ₁₆	read safety input slave "interpretation data"	3	4
page 127	function 10 ₁₆	10 ₁₆	read addresses of safety slaves	3	6

Values for command

see page	Command	Value	Meaning	Req Len	Res Len
page 112	EXT_DIAG	71 ₁₆	ExtDiag generation	6	2
page 113	RD_EXT_DIAG	7B ₁₆	Read ExtDiag Settings	2	7
page 114	INVERTER	7C ₁₆	Configure Inverter Slaves	12	4
page 114	MB_OP_CTRL_WR_FLAGS	0x85	Write Flags	≥5	2
page 115	MB_OP_CTRL_RD_FLAGS	0x86	Read Flags	4	≥3
page 115	RD_MFK_PARAM	0x59	Read SEW MFK21 Parameter	6	≥3

10.2.1 Values for results

	Value	Place	Meaning
OK	00 ₁₆	–	execution without fault
HI_NG	11 ₁₆	HI	general fault
HI_OPCODE	12 ₁₆	HI	illegal value in command
HI_LENGTH	13 ₁₆	HI	length of the command interface in the I/O-data area respectively the length of the DPV1 requests is too short
HI_ACCESS	14 ₁₆	HI	no access right
EC_NG	21 ₁₆	EC	general fault"
EC_SND	22 ₁₆	EC	slave (source addr) not detected
EC_SD0	23 ₁₆	EC	slave 0 detected
EC_SD2	24 ₁₆	EC	slave (target addr) not detected
EC_DE	25 ₁₆	EC	delete error
EC_SE	26 ₁₆	EC	set error
EC_AT	27 ₁₆	EC	address temporary
EC_ET	28 ₁₆	EC	extended ID1 temporary
EC_RE	29 ₁₆	EC	read (extended ID1) error

10.3 Commands of the Command Interface

10.3.1 AS-i 16-bit data

10.3.1.1 Overview of the commands

Values for command

see page	Command	Value	Meaning	Req Len	Res Len
page 75	RD_7X_IN	50 ₁₆	Read 1 16-bit slave profile in.data	3	10
page 75	WR_7X_OUT	51 ₁₆	Write 1 16-bit slave profile out.data	11	2
page 76	RD_7X_OUT	52 ₁₆	Read 1 16-bit slave profile out.data	3	10
page 76	RD_7X_IN_X	53 ₁₆	Read 4 16-bit slave profile in.data	3	34
page 77	WR_7X_OUT_X	54 ₁₆	Write 4 16-bit slave profile out.data	35	2
page 77	RD_7X_OUT_X	55 ₁₆	Read 4 16-bit slave profile out.data	3	34
page 78	OP_RD_16BIT_IN_CX	4C ₁₆	Read 16 channels 16-bit slave in.data	3	34
page 78	OP_WR_16BIT_IN_CX	4D ₁₆	Write 16 channels 16-bit slave in.data	36	2

Issue date: 24.8.2007

10.3.1.2 Read 1 16-bit Slave in.Data (RD_7X_IN)

With this command, the four 16 bit channels of an AS-i input slave according to the slave profile (S-7.3, S-7.4, S-7.5, S-7.A.8, S.A.9, S-7.A.A) can be read.

 Note	<p>A-Slaves map the data on channels 1 and 2. B-Slaves map the data on channels 3 and 4. Only values among 1 and 31 can be taken as a slave address.</p>
--	--

Request								
byte	2 ⁷	2 ⁶	2 ⁵	2 ⁴	2 ³	2 ²	2 ¹	2 ⁰
1	50 ₁₆							
2	T	–	circuit					
3	–		0	slave address				

Response								
byte	2 ⁷	2 ⁶	2 ⁵	2 ⁴	2 ³	2 ²	2 ¹	2 ⁰
1	50 ₁₆							
2	T	result						
3	channel 1, high byte							
...	...							
10	channel 4, low byte							

10.3.1.3 Write 1 16-bit Slave out.Data (WR_7X_OUT)

With this command, the four 16 bit channels of an AS-i output slave according to the slave profile (S-7.3, S-7.4, S-7.5, S-7.A.8, S.A.9, S-7.A.A) can be written.

Request								
byte	2 ⁷	2 ⁶	2 ⁵	2 ⁴	2 ³	2 ²	2 ¹	2 ⁰
1	51 ₁₆							
2	T	–	circuit					
3	–		0	slave address				
4	channel 1, high byte							
...	...							
11	channel 4, low byte							

Response								
byte	2 ⁷	2 ⁶	2 ⁵	2 ⁴	2 ³	2 ²	2 ¹	2 ⁰
1	51 ₁₆							
2	T	result						

Issue date - 24.8.2007

10.3.1.4 Read 1 16-bit Slave out.Data (RD_7X_OUT)

With this command, the four 16 bit channels of an AS-i output slave according to the slave profile (S-7.3, S-7.4, S-7.5, S-7.A.8, S.A.9, S-7.A.A) can be read out of the AS-i/PROFIBUS Gateway.

Request								
byte	2^7	2^6	2^5	2^4	2^3	2^2	2^1	2^0
1	52_{16}							
2	T	-	circuit					
3	-		0	slave address				
Response								
byte	2^7	2^6	2^5	2^4	2^3	2^2	2^1	2^0
1	52_{16}							
2	T	result						
3	channel 1, high byte							
...	...							
10	channel 4, low byte							

10.3.1.5 Read 4 16-bit Slave in.Data (RD_7X_IN_X)

With this command, the four 16-bit channels of 4 AS-i input slaves with successive addresses according to slave profile (S-7.3, S-7.4, S-7.5, S-7.A.8, S.A.9, S-7.A.A) can be read.

Request								
byte	2^7	2^6	2^5	2^4	2^3	2^2	2^1	2^0
1	53_{16}							
2	T	-	circuit					
3	-		0	1st slave address				
Response								
byte	2^7	2^6	2^5	2^4	2^3	2^2	2^1	2^0
1	53_{16}							
2	T	result						
3	1st slave, channel 1, high byte							
...	...							
34	4th slave, channel 4, low byte							

10.3.1.6 Write 4 7.3 Slave out.Data (WR_7X_OUT_X)

With this command the four 16-bit channels of four AS-i output slaves with successive addresses according to slave profile (S-7.3, S-7.4, S-7.5, S-7.A.8, S.A.9, S-7.A.A) can be written.

Request								
byte	2 ⁷	2 ⁶	2 ⁵	2 ⁴	2 ³	2 ²	2 ¹	2 ⁰
1	54 ₁₆							
2	T	–	circuit					
3	–		0	1st slave address				
4	1st slave, channel 1, high byte							
...	...							
35	4th slave, channel 4, low byte							

Response								
byte	2 ⁷	2 ⁶	2 ⁵	2 ⁴	2 ³	2 ²	2 ¹	2 ⁰
1	54 ₁₆							
2	T	result						

10.3.1.7 Read 4 7.3 Slave out.Data (RD_7X_OUT_X)

With this command, the four 16-bit channels of four AS-i output slaves with successive addresses according to slave profile (S-7.3, S-7.4, S-7.5, S-7.A.8, S.A.9, S-7.A.A) can be read.

Request								
byte	2 ⁷	2 ⁶	2 ⁵	2 ⁴	2 ³	2 ²	2 ¹	2 ⁰
1	55 ₁₆							
2	T	–	circuit					
3	–		0	1st slave address				

Response								
byte	2 ⁷	2 ⁶	2 ⁵	2 ⁴	2 ³	2 ²	2 ¹	2 ⁰
1	55 ₁₆							
2	T	result						
3	1st slave, channel 1, high byte							
...	...							
34	4th slave, channel 4, low byte							

10.3.1.8 Read 16 channels 16-bit Slave in.Data (OP_RD_16BIT_IN_CX)

With this command, the 16 channels of the 16-bit input-data for slaves with successive addresses according to slave profile (S-7.3, S-7.4, S-7.5, S-7.A.8, S.A.9, S-7.A.A) can be read

Request								
Byte	2^7	2^6	2^5	2^4	2^3	2^2	2^1	2^0
1	4C ₁₆							
2	T	-	circuit					
3	1. slave							
4	1. channel							
Response								
Byte	2^7	2^6	2^5	2^4	2^3	2^2	2^1	2^0
1	4C ₁₆							
2	T	result						
3	1. slave, channel 1, high byte							
4	1. slave, channel 1, low byte							
...	...							
33	16. channel, high byte							
34	16. channel, low byte							

10.3.1.9 Write 16 channels 16-bit slave out.Data (OP_WR_16BIT_IN_CX)

With this command, the 16 channels of the 16-bit input-data for slaves with successive addresses according to slave profile (S-7.3, S-7.4, S-7.5, S-7.A.8, S.A.9, S-7.A.A) can be written.

Request								
Byte	2^7	2^6	2^5	2^4	2^3	2^2	2^1	2^0
1	4D ₁₆							
2	T	circuit						
3	1. slave							
4	1. channel							
5	1. slave, 1. channel, high byte							
6	1. slave, 1. channel, low byte							
...	...							
35	16. channel, high byte							
36	16. channel, low byte							
Response								
Byte	2^7	2^6	2^5	2^4	2^3	2^2	2^1	2^0
1	4D ₁₆							
2	T	result						

Issue date: 24.8.2007

10.3.2 Commands acc. to Profile S-7.4/S-7.5

10.3.2.1 Overview of the commands

Values for command

see page	Command	Value	Meaning	Req Len	Res Len
page 79	WR_74_75_PARAM	5A ₁₆	Write S-7.4/S-7.5-slave parameter	≥6	2
page 80	RD_74_75_PARAM	5B ₁₆	Read S-7.4/S-7.5-slave parameter	4	≥3
page 81	RD_74_75_ID	5C ₁₆	Read S-7.4/S-7.5-slave ID string	4	≥3
page 81	RD_74_DIAG	5D ₁₆	Read S-7.4/S-7.5-slave diagnosis string	4	≥3

10.3.2.2 WR_74_75_PARAM

Description:

- with this function the parameter string of a slave according to profile S-7.4 is being written

or

- the data transfer with a slave according to profile S-7.5 is started.

If it is about a slave according to profile 7.5, data have to be registered into the buffer in the same form, as they have to be sent by AS-i.

Since the string can be longer than the command interface, it will partly be written into the buffer and then be transferred to the slave.

n is the length of the part of the string which should be written into the buffer from index i on.

If $i = 0$, then the string is being transferred to the slave.

Request								
byte	2 ⁷	2 ⁶	2 ⁵	2 ⁴	2 ³	2 ²	2 ¹	2 ⁰
1	5A ₁₆							
2	T	–	circuit					
3	slave address							
4	i							
5	n							
6	buffer byte i							
...	...							
n+5	buffer byte i+n-1							

Response								
byte	2 ⁷	2 ⁶	2 ⁵	2 ⁴	2 ³	2 ²	2 ¹	2 ⁰
1	5A ₁₆							
2	T	results						

10.3.2.3 RD_74_75_PARAM

Description:

- with this function the parameter string of a slave according to profile S-7.4 is being read

or

- the slave response according to profile S-7.5 is being read.

If it is about a slave according to profile 7.5, so have the data in the response buffer the following meaning:

FFh 00h: Transfer is still active

FFh xxh: Transfer finished with error

The first byte in the buffer not equal FFH: slave response. The response is in the same form registered in the buffer and transmitted over AS-i.

Since the string can be longer than the command interface, it is written into the buffer. The content of the buffer can read in parts from index i.

The first byte of the buffer is the length of the read string.

If $i \equiv 0$, the string is being read from the slave, otherwise the function responses out of the memory; the data can be read consistently.

Request								
byte	2^7	2^6	2^5	2^4	2^3	2^2	2^1	2^0
1	$5B_{16}$							
2	T	-	circuit					
3	slave address							
4	i							

Response								
byte	2^7	2^6	2^5	2^4	2^3	2^2	2^1	2^0
1	$5B_{16}$							
2	T	result						
3	buffer byte i							
...	...							
n+2	buffer byte i+n-1							

10.3.2.4 RD_74_75_ID

With this function the ID string of a slave according to profile S-7.4 or the 16-bit slave configuration according to profile 7.5 is being read. Since the string can be longer than the command interface, it is written into the buffer. The content of the buffer can read in parts from index i.

The first byte of the buffer is the length of the read string.

If $i \equiv 0$, the string is being read from the slave, otherwise the function responses out of the memory, the data can be read consistently.

Request								
byte	2^7	2^6	2^5	2^4	2^3	2^2	2^1	2^0
1	5C ₁₆							
2	T	–	circuit					
3	slave address							
4	i							

Response								
byte	2^7	2^6	2^5	2^4	2^3	2^2	2^1	2^0
1	5C ₁₆							
2	T	result						
3	buffer byte i							
...	...							
n+2	buffer byte i+n-1							

By a 7.5 slave is the request always 1. The response byte contains the cyclic 16-bit slave configuration according to S-7.5 profile (analog/transparent bits are cancelled). If the response is 08h, that means that the cyclic 16-bit configuration could not be detected.

10.3.2.5 RD_74_DIAG

With this function the diagnosis string of a slave according to profile S-7.4 is being read. Since the string can be longer than the command interface, it is written into the buffer. The content of the buffer can be read in parts from index i.

The first byte of the buffer indicates the length of the read string.

If $i \equiv 0$, the string is being read from the slave, otherwise the function responses out of the memory, the data can be read consistently.

Request								
byte	2^7	2^6	2^5	2^4	2^3	2^2	2^1	2^0
1	5D ₁₆							
2	T	–	circuit					
3	slave address							
4	i							

Response								
byte	2^7	2^6	2^5	2^4	2^3	2^2	2^1	2^0
1	5D ₁₆							
2	T	result						
3	buffer byte i							
...	...							
n+2	buffer byte i+n-1							

10.3.3 Acyclic commands

10.3.3.1 Overview of the commands

Values for command

see page	Command	Value	Meaning	Req Len	Res Len
page 82	WRITE_ACYC_TRANS	4E ₁₆	Write acyclic transfer	≥7	2
page 84	READ_ACYC_TRANS	4F ₁₆	Read acyclic transfer	5	≥2

10.3.3.2 WRITE_ACYCLIC_TRANS

This function activates different arts of acyclic transfer (S-7.4, S-7.5 and safety monitor). The results have to be read out with READ_ACYCLIC_TRANS. Even though this function runs in the background and doesnt hold the master during the transmission, it ist intended to act as a substitute for (RD_74_75_PARAM, WR_74_75_PARAM, RD_74_75_ID, RD_74_DIAG and „Safety at Work“- monitor diagnnestic).

Since the transferred data can be longer than the command interface, it is written into the buffer. The content of the buffer can be read in parts from index.

n is the length of the part string, that (from Index (i)) should be written in the buffer. The transmission proceeds, if i=0.

Request								
Byte	2^7	2^6	2^5	2^4	2^3	2^2	2^1	2^0
1	4Eh							
2	circuit							
3	slave							
4	buffer Index (i) high							
5	buffer Index (i) low							
6	command ¹							
7	number of(n)							
8	data							
...	...							
x	data+n							

Issue date - 24.8.2007

1. Following commands are supported:
 - 1: S-7.4 ID string Read (no sent data required).
 - 2: S-7.4 Diag String Read (no sent data required).
 - 3: S-7.4 Param String Read (no sent data required).
 - 4: S-7.4 Param String Write (buffer contains sent string).
 - 5: S-7.5 Transfer. Buffer contains sent string in the same form, as the telegram, that have to be sent over AS-i.
 - 6: S-7.5 Cyclic 16-Bit Slave Configuration Read (analog/transparent bits are cancelled in the response). The cyclic 16-bit configuration cannot be detected, if the response is 08h.
 - 7: Safety Monitor sorted Read (no sent data required).
 - 8: Safety Monitor unsorted (all devices) Read (no sent data required).

 Note	Please view <chapter 10.4.2 Monitor Diagnosis> for further information.
--	---

Response								
Byte	2^7	2^6	2^5	2^4	2^3	2^2	2^1	2^0
1	$4E_{16}$							
2	response							

10.3.3.3 READ_ACYCLIC_TRANS

With this call the response of the transfer command (started with WRITE_ACYCLIC_TRANS) is read out.

The first byte in the response buffer indicates the current command.

FF₁₆ means transfer still active, FE₁₆ means transfer interrupted with errors.

The both following bytes (high,low) set the length of the response buffer.

It is always recommended to read the data starting with the index $i = 0$.

Request								
Byte	2 ⁷	2 ⁶	2 ⁵	2 ⁴	2 ³	2 ²	2 ¹	2 ⁰
1	4F ₁₆							
2	circuit							
3	slave							
4	buffer index (i) high							
5	buffer index (i) low							

Response								
Byte	2 ⁷	2 ⁶	2 ⁵	2 ⁴	2 ³	2 ²	2 ¹	2 ⁰
1	4F ₁₆							
2	response							
3	data							
...	...							
x	data+n							

The response data have the same format, as by commands RD_74_75_PARAM, RD_74_75_ID and „safety at work“-monitor diagnostics.

10.3.4 AS-i Diagnosis

10.3.4.1 Overview of the commands

Values for command

see page	Command	Value	Meaning	Req Len	Res Len
page 85	GET_LISTS	30 ₁₆	Get LDS, LAS, LPS, Flags	2	29
page 87	GET_FLAGS	47 ₁₆	Get_Flags	2	5
page 88	GET_DELTA	57 ₁₆	Get list of config. diff.	2	10
page 89	GET_LCS	60 ₁₆	Get LCS	2	10
page 89	GET_LAS	45 ₁₆	Get_LAS	2	10
page 90	GET_LDS	46 ₁₆	Get_LDS	2	10
page 91	GET_LPF	3E ₁₆	Get_LPF	2	10
page 91	GET_LOS	61 ₁₆	GET_LOS	2	10
page 92	SET_LOS	62 ₁₆	SET_LOS	10	2
page 93	GET_TECA	63 ₁₆	Get transm.err.counters	2	34
page 94	GET_TECB	64 ₁₆	Get transm.err.counters	2	34
page 94	GET_TEC_X	66 ₁₆	Get transm.err.counters	4	≥3
page 95	READ_FAULT_DETECTOR	10 ₁₆	Read Fault Detector	2	4
page 96	READ_DUPLICATE_ADDR	11 ₁₆	Read List of Duplicate Addresses	2	10

10.3.4.2 Get Lists and Flags (Get_LPS, Get_LAS, Get_LDS, Get_Flags) (GET_LISTS)

With this call, the following entries are read out of the AS-i/PROFIBUS Gateway:

- The list of active AS-i slaves (LAS)
- The list of detected AS-i slaves (LDS)
- The list of projected AS-i slaves (LPS)
- The flags according to the AS-i slave specification

Request								
byte	2 ⁷	2 ⁶	2 ⁵	2 ⁴	2 ³	2 ²	2 ¹	2 ⁰
1	30 ₁₆							
2	T	O	circuit					

Response (if O ≡ 0)								
byte	2 ⁷	2 ⁶	2 ⁵	2 ⁴	2 ³	2 ²	2 ¹	2 ⁰
1	30 ₁₆							
2	T	result						
3	7A	6A	5A	4A	3A	2A	1A	0A
...	LAS							
10	31B	30B	29B	28B	27B	26B	25B	24B
11	7A	6A	5A	4A	3A	2A	1A	0A
...	LDS							
18	31B	30B	29B	28B	27B	26B	25B	24B
19	7A	6A	5A	4A	3A	2A	1A	0A
...	LPS							
26	31B	30B	29B	28B	27B	26B	25B	24B
27	-							Pok
28	OR	APF	NA	CA	AAv	AAAs	S0	Cok
29	-					AAe	OL	DX

Response (if O ≡ 1)								
byte	2 ⁷	2 ⁶	2 ⁵	2 ⁴	2 ³	2 ²	2 ¹	2 ⁰
1	30 ₁₆							
2	T	result						
3	0A	1A	2A	3A	4A	5A	6A	7A
...	LAS							
10	24B	25B	26B	27B	28B	29B	30B	31B
11	0A	1A	2A	3A	4A	5A	6A	7A
...	LDS							
18	24B	25B	26B	27B	28B	29B	30B	31B
19	0A	1A	2A	3A	4A	5A	6A	7A
...	LPS							
26	24B	25B	26B	27B	28B	29B	30B	31B
27	-							Pok
28	OR	APF	NA	CA	AAv	AAAs	S0	Cok
29	-					AAe	OL	DX

Pok Periphery_Ok
 S0 LDS.0
 AAAs Auto_Address_Assign
 AAv Auto_Address_Available
 CA Configuration_Active
 NA Normal_Operation_Active
 APF APF
 OR Offline_Ready

Issue date - 24.8.2007

Cok Config_Ok
 AAe Auto_Address_Enable
 OL Offline
 DX Data_Exchange_Active

10.3.4.3 Get Flags (GET_FLAGS)

With this call, the following entry is read out of the AS-i/PROFIBUS Gateway: the flags according to the AS-i slave specification.

Request								
byte	2 ⁷	2 ⁶	2 ⁵	2 ⁴	2 ³	2 ²	2 ¹	2 ⁰
1	47 ₁₆							
2	T	-	circuit					
Response								
byte	2 ⁷	2 ⁶	2 ⁵	2 ⁴	2 ³	2 ²	2 ¹	2 ⁰
1	47 ₁₆							
2	T	response						
3								Pok
4	OR	APF	NA	CA	AAv	AAe	S0	Cok
5	-					AAe	OL	DX

- Pok Periphery_Ok
This flag is set when no AS-i slave is signaling a peripheral fault.
- S0 LDS.0
This flag is set when an AS-i slave with address 0 exists.
- AAe Auto_Address_Assign
This flag is being set when the automatic address programming is possible (in other words, AUTO_ADDR_ENABLE = 1; no "incorrect" slave connected to the AS-i).
- AAv Auto_Address_Available
This flag is set when the automatic address programming can be executed, exactly one AS-i slave is currently out of operation.
- CA Configuration_Active
The flag is set in configuration mode and reset in protected mode.
- NA Normal_Operation_Active
This flag is set when the AS-i master is in normal operation.
- APF AS-i Power Fail
This flag is set when the voltage on the AS-i cable is too low.
- OR Offline_Ready
The flag is set when the offline phase is active.

Cok Config_Ok

This flag is set when the desired (configured) and actual configuration match.

AAe Auto_Address_Enable

This flag indicates whether the automatic address programming is enabled (bit = 1) or disabled (bit = 0) by the user.

OL Offline

This flag is set when the mode should be changed to OFFLINE or when this mode has already been reached.

DX Data_Exchange_Active

If the "Data_Exchange_Active" flag is set, the data exchange between AS-i master and slaves is available in the data exchange phase. If this bit is not set the data exchange is not available. The read ID telegrams are transmitted to the slave.

The bit is set if the AS-i master enters the offline phase.

10.3.4.4 Get Delta List (GET_DELTA)

The delta list contains the list of slave addresses with configuration errors.

Request									
byte	2^7	2^6	2^5	2^4	2^3	2^2	2^1	2^0	
1	57_{16}								
2	T	0	circuit						

Response (if O ≡ 0)								
byte	2^7	2^6	2^5	2^4	2^3	2^2	2^1	2^0
1	57_{16}							
2	T	result						
3	7A	6A	5A	4A	3A	2A	1A	–
...	...							
10	31B	30B	29B	28B	27B	26B	25B	24B

Response (if O ≡ 1)								
byte	2^7	2^6	2^5	2^4	2^3	2^2	2^1	2^0
1	57_{16}							
2	T	result						
3	0	1A	2A	3A	4A	5A	6A	7A
...	...							
10	24B	25B	26B	27B	28B	29B	30B	31B

10.3.4.5 Get list of corrupted Slaves (GET_LCS and GET_LCS_R6 (6CH))

The call GET_LCS_R6 (6CH) differs to the call GET_LCS in the half long LCS list.

With the bit 2^5 is selected if the upper (=1) or lower (=0) part of the LCS is read. Read first with 2^5 in order to create a local copy of the LCS. Reading with bit $2^5=1$ transmits the upper part of the copy.

With the call GET_LCS, the List of Corrupted Slaves (LCS) is read out of the AS-i/PROFIBUS Gateway.

Request								
byte	2^7	2^6	2^5	2^4	2^3	2^2	2^1	2^0
1	60_{16}							
2	T	O	circuit					

Response (if $O \equiv 0$)								
byte	2^7	2^6	2^5	2^4	2^3	2^2	2^1	2^0
1	60_{16}							
2	T	result						
3	7A	6A	5A	4A	3A	2A	1A	0A
...	...							
10	31B	30B	29B	28B	27B	26B	25B	24B

Response (if $O \equiv 1$)								
byte	2^7	2^6	2^5	2^4	2^3	2^2	2^1	2^0
1	60_{16}							
2	T	result						
3	0A	1A	2A	3A	4A	5A	6A	7A
...	...							
10	24B	25B	26B	27B	28B	29B	30B	31B

10.3.4.6 Get list of activated Slaves (GET_LAS)

With this call, the following entry is read out of the AS-i/PROFIBUS Gateway: The list of activated slaves (LAS).

Request								
byte	2^7	2^6	2^5	2^4	2^3	2^2	2^1	2^0
1	45_{16}							
2	T	O	circuit					

Response (if O ≡ 0)								
byte	2 ⁷	2 ⁶	2 ⁵	2 ⁴	2 ³	2 ²	2 ¹	2 ⁰
1	45 ₁₆							
2	T	result						
3	7A	6A	5A	4A	3A	2A	1A	0A
...	...							
10	31B	30B	29B	28B	27B	26B	25B	24B

Response (if O ≡ 1)								
byte	2 ⁷	2 ⁶	2 ⁵	2 ⁴	2 ³	2 ²	2 ¹	2 ⁰
1	45 ₁₆							
2	T	result						
3	0A	1A	2A	3A	4A	5A	6A	7A
...	...							
10	24B	25B	26B	27B	28B	29B	30B	31B

10.3.4.7 Get list of detected AS-i Slaves (GET_LDS)

With this call, the following entry is read out of the AS-i/PROFIBUS Gateway: The list of detected AS-i slaves (*LDS*).

Request								
byte	2 ⁷	2 ⁶	2 ⁵	2 ⁴	2 ³	2 ²	2 ¹	2 ⁰
1	46 ₁₆							
2	T	O	circuit					

Response (if O ≡ 0)								
byte	2 ⁷	2 ⁶	2 ⁵	2 ⁴	2 ³	2 ²	2 ¹	2 ⁰
1	46 ₁₆							
2	T	result						
3	7A	6A	5A	4A	3A	2A	1A	0A
...	...							
10	31B	30B	29B	28B	27B	26B	25B	24B

Response (if O ≡ 1)								
byte	2 ⁷	2 ⁶	2 ⁵	2 ⁴	2 ³	2 ²	2 ¹	2 ⁰
1	46 ₁₆							
2	T	result						
3	0A	1A	2A	3A	4A	5A	6A	7A
...	...							
10	24B	25B	26B	27B	28B	29B	30B	31B

Issue date - 24.8.2007

10.3.4.8 Get list of peripheral faults (GET_LPF)

With this call, the list of peripheral faults (*LPF*) signaled by the AS-i slaves is read out from the AS-i master. The LPF is updated cyclically by the AS-i master. If and when an AS-i slave signals faults of the attached peripherals (for example broken wire) can be found in the description of the AS-i slave.

Request								
byte	2 ⁷	2 ⁶	2 ⁵	2 ⁴	2 ³	2 ²	2 ¹	2 ⁰
1	3E ₁₆							
2	T	O	circuit					

Response (if O ≡ 0)								
byte	2 ⁷	2 ⁶	2 ⁵	2 ⁴	2 ³	2 ²	2 ¹	2 ⁰
1	3E ₁₆							
2	T	result						
3	7A	6A	5A	4A	3A	2A	1A	0A
...	...							
10	31B	30B	29B	28B	27B	26B	25B	24B

Response (if O ≡ 1)								
byte	2 ⁷	2 ⁶	2 ⁵	2 ⁴	2 ³	2 ²	2 ¹	2 ⁰
1	3E ₁₆							
2	T	result						
3	0A	1A	2A	3A	4A	5A	6A	7A
...	...							
10	24B	25B	26B	27B	28B	29B	30B	31B

10.3.4.9 Get list of offline Slaves (GET_LOS)

With this call, the list of slaves causing the offline phase when a configuration error occurs in being read out (List of Offline Slaves, *LOS*).

The user can choose the reaction of the master when a configuration error occurs. The master can be switched off line when an important slave causes a configuration error; less important slaves can send an error to the host, AS-i however will not be switched offline.

Request								
byte	2^7	2^6	2^5	2^4	2^3	2^2	2^1	2^0
1	61_{16}							
2	T	O	circuit					

Response (if O ≡ 0)								
byte	2^7	2^6	2^5	2^4	2^3	2^2	2^1	2^0
1	61_{16}							
2	T	result						
3	7A	6A	5A	4A	3A	2A	1A	0A
...	...							
10	31B	30B	29B	28B	27B	26B	25B	24B

Response (if O ≡ 1)								
byte	2^7	2^6	2^5	2^4	2^3	2^2	2^1	2^0
1	61_{16}							
2	T	result						
3	0A	1A	2A	3A	4A	5A	6A	7A
...	...							
10	24B	25B	26B	27B	28B	29B	30B	31B

10.3.4.10 Set list of offline Slaves (SET_LOS and SET_LOS_R6 (6Dh))

The call **SET_LOS_R6 (6D₁₆)** differs to the call GET_LOS in the half long LOS list.

With the bit 2^5 is selected if the upper (=1) or lower (=0) part of the LOS is written.

With this call, the list of slaves causing the offline phase when a configuration error occurs in being defined (List of Offline Slaves, LOS).

The user can choose the reaction of the master when a configuration error occurs. The master can be switched offline when an important slave causes a configuration error; less important slaves can send an error to the host, AS-i however will not be switched offline.

Request (if O ≡ 0)								
byte	2^7	2^6	2^5	2^4	2^3	2^2	2^1	2^0
1	62_{16}							
2	T	O	circuit					
3	7A	6A	5A	4A	3A	2A	1A	0A
...	...							
10	31B	30B	29B	28B	27B	26B	25B	24B

Issue date - 24.8.2007

Request (if O ≡ 1)								
byte	2 ⁷	2 ⁶	2 ⁵	2 ⁴	2 ³	2 ²	2 ¹	2 ⁰
1	62 ₁₆							
2	T	1	circuit					
3	0A	1A	2A	3A	4A	5A	6A	7A
...	...							
10	24B	25B	26B	27B	28B	29B	30B	31B

Response								
byte	2 ⁷	2 ⁶	2 ⁵	2 ⁴	2 ³	2 ²	2 ¹	2 ⁰
1	62 ₁₆							
2	T	result						

10.3.4.11 Get transm.err.counters (GET_TECA)

 Note	In order to get the real number of transcription errors, multiply the value with 2
--	--

With this call the error counters of all single slaves/A-slaves can be read (see chapter 8).

With every reading out of the counts, the error counters will be restarted.

The counts are being read out via the corresponding host interface and will be deleted with every read access. The counter's value is limited to 254. 255 will cause a counter overflow.

The counts could be independent of the counters, which are displayed in the display of the gateway.

Request								
byte	2 ⁷	2 ⁶	2 ⁵	2 ⁴	2 ³	2 ²	2 ¹	2 ⁰
1	63 ₁₆							
2	T	-	circuit					

Response								
byte	2 ⁷	2 ⁶	2 ⁵	2 ⁴	2 ³	2 ²	2 ¹	2 ⁰
1	63 ₁₆							
2	T	result						
3	APF							
4	slave 1A							
...	...							
34	slave 31A							

Issue date - 24.8.2007

10.3.4.12 Get transm.err.counters (GET_TECB)

 Note	In order to get the real number of transcription errors, multiply the value with 2
--	--

With this call, the counts of the error counters for B-slaves are being read out (see chapter 8).

With every reading out of the counts, the error counters will be restarted.

The counts are being read out via the corresponding host interface and will be deleted with every read access. The counter's value is limited to 254. 255 will cause a counter overflow.

The counts could be independent of the counters, which are displayed in the display of the gateway.

Request								
byte	2^7	2^6	2^5	2^4	2^3	2^2	2^1	2^0
1	64_{16}							
2	T	-	circuit					

Response								
byte	2^7	2^6	2^5	2^4	2^3	2^2	2^1	2^0
1	64_{16}							
2	T	result						
3	APF							
4	slave 1B							
...	...							
34	slave 31B							

10.3.4.13 Get transm.err.counters (GET_TEC_X)

Beginning with a definite slave address, the counts of the n error counters are being read out with this call.

With every reading out the counts, the error counters will be restarted.

The counts are being read out via the corresponding host interface and will be deleted with every read access. The counter's value is limited to 254. 255 will cause a counter overflow.

The counts could be independent of the counters, which are displayed in the display of the gateway.

Request								
byte	2 ⁷	2 ⁶	2 ⁵	2 ⁴	2 ³	2 ²	2 ¹	2 ⁰
1	66 ₁₆							
2	T	–	circuit					
3	1. slave address							
4	number of counters							

Response								
byte	2 ⁷	2 ⁶	2 ⁵	2 ⁴	2 ³	2 ²	2 ¹	2 ⁰
1	66 ₁₆							
2	T	result						
3	counter 1							
...	...							
n	counter n - 2							

10.3.4.14 Read fault detector (READ_FAULT_DETECTOR)

With this call all informations of the AS-i detector are read out. In the first byte are stored the values transferred in the moment, in the second all values since the last deleting. By it it is possible to recognize immediate, no more existing before messages also. The second byte is deleted by reading.

Request								
byte	2 ⁷	2 ⁶	2 ⁵	2 ⁴	2 ³	2 ²	2 ¹	2 ⁰
1	10 ₁₆							
2	T	–	circuit					

Response								
byte	2 ⁷	2 ⁶	2 ⁵	2 ⁴	2 ³	2 ²	2 ¹	2 ⁰
1	10 ₁₆							
2	T	result						
3	DA	ST	US	ES	24 V	reserved		
4	DA	ST	US	ES	24 V	reserved		

DA duplicate address

ST noise

US over voltage

ES earth fault

24 V failure of the redundant 24V

10.3.4.15 Read list of duplicate addresses (READ_DUPLICATE_ADDR)

With this call the list of slaves with duplicate addresses (the assignment of one address to two slaves) is read out.

Request								
byte	2^7	2^6	2^5	2^4	2^3	2^2	2^1	2^0
1	11_{16}							
2	T	O	circuit					

Response (if O ≡ 0)								
byte	2^7	2^6	2^5	2^4	2^3	2^2	2^1	2^0
1	11_{16}							
2	T	result						
3	7A	6A	5A	4A	3A	2A	1A	0A
...	...							
10	31B	30B	29B	28B	27B	26B	25B	24B

Response (if O ≡ 1)								
byte	2^7	2^6	2^5	2^4	2^3	2^2	2^1	2^0
1	11_{16}							
2	T	result						
3	0A	1A	2A	3A	4A	5A	6A	7A
...	...							
10	24B	25B	26B	27B	28B	29B	30B	31B



Note

Further diagnosis functions for "Safety at Work" and for availability (resp. for warnings) of integrated sensors are detailed explained in the chapter "Functional profiles" (chapter 10.4).

10.3.5 Configuration of AS-i Master

10.3.5.1 Overview of the commands

Values for command

<i>see page</i>	<i>Command</i>	<i>Value</i>	<i>Meaning</i>	<i>Req Len</i>	<i>Res Len</i>
<i>page 97</i>	SET_OP_MODE	0C ₁₆	Set_Operation_Mode	3	2
<i>page 98</i>	STORE_CDI	07 ₁₆	Store_Actual_Configuration	2	2
<i>page 98</i>	READ_CDI	28 ₁₆	Read_Actual_Configuration	3	4
<i>page 99</i>	SET_PCD	25 ₁₆	Set_Permanent_Config	5	2
<i>page 99</i>	GET_PCD	26 ₁₆	Get_Permanent_Config	3	4
<i>page 100</i>	SET_LPS	29 ₁₆	SET_LPS	11	2
<i>page 101</i>	GET_LPS	44 ₁₆	Get_LPS	2	10
<i>page 102</i>	STORE_PI	04 ₁₆	Store_Actual_Parameter	2	2
<i>page 102</i>	WRITE_P	02 ₁₆	Write_Parameter	4	3
<i>page 103</i>	READ_PI	03 ₁₆	Read_Parameter	3	3
<i>page 103</i>	SET_PP	43 ₁₆	Set_Permanent_Parameter	4	2
<i>page 104</i>	GET_PP	01 ₁₆	Get_Permanent_Parameter	3	3
<i>page 104</i>	SET_AAE	0B ₁₆	Set_Auto_Address_Enable	3	2
<i>page 107</i>	SLAVE_ADDR	0D ₁₆	Change_Slave_Address	4	2
<i>page 106</i>	WRITE_XID1	3F ₁₆	Write_Extended_ID-Code_1	3	2

10.3.5.2 Set operation mode (SET_OP_MODE: Set_Operation_Mode)

This call switches between configuration mode and protected mode. In protected mode, only AS-i slaves entered in the LPS and whose expected and actual configurations match, are being activated.

In other words: The slaves are being activated if the I/O configuration and the ID codes of the detected AS-i slaves are identical to the configured values.

In configuration mode, all detected AS-i slaves (except for AS-i slave "0") are activated. This also applies to AS-i slaves for which there are differences between the expected and actual configuration.

The "OPERATION MODE" bit is stored permanently; in other words, it is retained after a cold/warm restart.

When you change from configuration mode to protected mode, the AS-i master will do a warm restart (change to the offline phase followed by a change to the online mode).



Note

If an AS-i slave with address "0" is entered in the LDS, the AS-i/PROFIBUS Gateway cannot change from configuration mode to protected mode.

Request								
byte	2^7	2^6	2^5	2^4	2^3	2^2	2^1	2^0
1	$0C_{16}$							
2	T	-	circuit					
3	operation mode							

Response								
byte	2^7	2^6	2^5	2^4	2^3	2^2	2^1	2^0
1	$0C_{16}$							
2	T	result						

Meaning of bit operation mode:

- 0 = protected mode
- 1 = configuration mode

10.3.5.3 Store actual configuration (STORE_CDI)

With this call, the (actual) configuration data (I/O configuration, ID code, extended ID1 code and extended ID2 code) of all AS-i slaves are stored permanently in the EEPROM as the (expected) configuration data. The list of activated AS-i slaves (*LAS*) is adopted in the list of permanent AS-i slaves (*LPS*).

When this command is executed, the AS-i master changes to the offline phase and then changes back to the normal mode (warm restart on the AS-i master).

This command can only be executed in the configuration mode.

Request								
byte	2^7	2^6	2^5	2^4	2^3	2^2	2^1	2^0
1	07_{16}							
2	T	-	circuit					

Response								
byte	2^7	2^6	2^5	2^4	2^3	2^2	2^1	2^0
1	07_{16}							
2	T	result						

10.3.5.4 Read actual configuration (READ_CDI)

With this call, the following configuration data of an addressed AS-i slave obtained by the AS-i master on the AS-Interface are read.

- I/O configuration
- ID code
- Extended ID1 code
- Extended ID2 code

The configuration data are specified by the manufacturer of the AS-i slave.

Request								
byte	2 ⁷	2 ⁶	2 ⁵	2 ⁴	2 ³	2 ²	2 ¹	2 ⁰
1	28 ₁₆							
2	T	–	circuit					
3	–		B	slave address				

Response								
byte	2 ⁷	2 ⁶	2 ⁵	2 ⁴	2 ³	2 ²	2 ¹	2 ⁰
1	28 ₁₆							
2	T	result						
3	xID2				xID1			
4	ID				IO			

Meaning of bit B:

B = 0 Single AS-i slave or A-slave

B = 1 B-slave

10.3.5.5 Set permanent configuration (SET_PCD)

This call sets the following configuration data for the addressed AS-i slave:

- I/O configuration
- ID code
- Extended ID1 code
- Extended ID2 code

The configuration data are stored permanently on the EEPROM of the AS-i/PROFIBUS gateway and are used as the expected configuration by the AS-i master in the protected mode. The configuration data are specified by the manufacturer of the AS-i slave.

If the addressed AS-i slave does not support an extended ID code 1/2, the value F_{hex} must be specified.

When this command is executed, the AS-i master changes to the offline phase and then changes back to the normal mode (warm restart).

This command can only be executed in the configuration mode.

Request								
byte	2 ⁷	2 ⁶	2 ⁵	2 ⁴	2 ³	2 ²	2 ¹	2 ⁰
1	25 ₁₆							
2	T	–	circuit					
3	–		B	slave address				
4	xID2				xID1			
5	ID				IO			

Response								
byte	2^7	2^6	2^5	2^4	2^3	2^2	2^1	2^0
1	25_{16}							
2	T	result						

Meaning of bit B:

B = 0 Single AS-i slave or A-slave

B = 1 B-slave

10.3.5.6 Get extended permanent configuration (GET_PCD)

This call reads the following configuration data (configured data) of an addressed AS-i slave stored on the EEPROM of the AS-i master:

- I/O configuration
- ID code
- Extended ID1 code
- Extended ID2 code

The configuration data are specified by the manufacturer of the AS-i slave.

Request								
byte	2^7	2^6	2^5	2^4	2^3	2^2	2^1	2^0
1	26_{16}							
2	T	–	circuit					
3	–		B	slave address				

Response								
byte	2^7	2^6	2^5	2^4	2^3	2^2	2^1	2^0
1	26_{16}							
2	T	result						
3	xID2				xID1			
4	ID				I0			

Meaning of bit B:

B = 0 Single AS-i slave or A-slave

B = 1 B-slave

10.3.5.7 Set list of projected slaves (SET_LPS and SET_LPS_R6 (6Bh))

The command **SET_LPS_R6 (6Bh)** differs from the command **SET-LPs** in:

- no empty byte (3)
- half so long LPS list

With the bit 2^5 is selected if the upper (=1) or lower (=0) part of the LCS is read.

With this call, the list of configured AS-i slaves is transferred for permanent storage in the EEPROM of the master.

When this command is executed, the AS-i master changes to the offline phase and then changes back to the normal mode (warm restart).

Issue date - 24.8.2007

This command can only be executed in the configuration mode.

Request (if O ≡ 0)								
byte	2 ⁷	2 ⁶	2 ⁵	2 ⁴	2 ³	2 ²	2 ¹	2 ⁰
1	29 ₁₆							
2	T	0	circuit					
3	00 ₁₆							
4	7A	6A	5A	4A	3A	2A	1A	–
...	...							
11	31B	30B	29B	28B	27B	26B	25B	24B

Request (if O ≡ 1)								
byte	2 ⁷	2 ⁶	2 ⁵	2 ⁴	2 ³	2 ²	2 ¹	2 ⁰
1	29 ₁₆							
2	T	1	circuit					
3	00 ₁₆							
4	–	1A	2A	3A	4A	5A	6A	7A
...	...							
11	24B	25B	26B	27B	28B	29B	30B	31B

Response								
byte	2 ⁷	2 ⁶	2 ⁵	2 ⁴	2 ³	2 ²	2 ¹	2 ⁰
1	29 ₁₆							
2	T	result						

10.3.5.8 Get list of projected slaves (GET_LPS)

With this call, the following entry is read out of the AS-i/PROFIBUS Gateway: The list of projected AS-i slaves (LPS).

Request								
byte	2 ⁷	2 ⁶	2 ⁵	2 ⁴	2 ³	2 ²	2 ¹	2 ⁰
1	44 ₁₆							
2	T	O	circuit					

Response (if O ≡ 0)								
byte	2 ⁷	2 ⁶	2 ⁵	2 ⁴	2 ³	2 ²	2 ¹	2 ⁰
1	44 ₁₆							
2	T	result						
3	7A	6A	5A	4A	3A	2A	1A	0A
...	...							
10	31B	30B	29B	28B	27B	26B	25B	24B

Response (if O = 1)								
byte	2 ⁷	2 ⁶	2 ⁵	2 ⁴	2 ³	2 ²	2 ¹	2 ⁰
1	44 ₁₆							
2	T	result						
3	0A	1A	2A	3A	4A	5A	6A	7A
...	...							
10	24B	25B	26B	27B	28B	29B	30B	31B

10.3.5.9 Store actual parameters (STORE_PI)

With this call, the configured parameters stored on the EEPROM are overwritten with the current, permanently stored (actual) parameters; in other words, the current parameters of all AS-i slaves are stored.

Request								
byte	2 ⁷	2 ⁶	2 ⁵	2 ⁴	2 ³	2 ²	2 ¹	2 ⁰
1	04 ₁₆							
2	T	-	circuit					

Response								
byte	2 ⁷	2 ⁶	2 ⁵	2 ⁴	2 ³	2 ²	2 ¹	2 ⁰
1	04 ₁₆							
2	T	result						

10.3.5.10 Write parameter (WRITE_P)

The AS-i slave parameter value transferred with the command is passed on to the addressed AS-i slave.

The parameter is stored in the AS-i/PROFIBUS Gateway only temporarily and is not stored as a configured parameter in the EEPROM!

The AS-i slave transfers its current parameter value in the response (parameter echo). This can deviate from the value that has just been written according to the AS-i master specification.

Request								
byte	2 ⁷	2 ⁶	2 ⁵	2 ⁴	2 ³	2 ²	2 ¹	2 ⁰
1	02 ₁₆							
2	T	-	circuit					
3	-		B	slave address				
4	-				parameter			

Response								
byte	2 ⁷	2 ⁶	2 ⁵	2 ⁴	2 ³	2 ²	2 ¹	2 ⁰
1	02 ₁₆							
2	T	result						
3	-				slave response			

Meaning of bit B:

B = 0 Single AS-i slave or A-slave

B = 1 B-slave

10.3.5.11 Read parameter (READ_PI: Read_Parameter)

This call returns the current parameter value (actual parameter) of an AS-i slave sent by the AS-i/PROFIBUS Gateway. This value must not be confused with the parameter echo that is supplied by the AS-i slave as a response to the write_p job. This command can not be used for a directly reading of an AS-i parameter out of an AS-i slave.

Request								
byte	2 ⁷	2 ⁶	2 ⁵	2 ⁴	2 ³	2 ²	2 ¹	2 ⁰
1	03 ₁₆							
2	T	-	circuit					
3	-		B	slave address				

Response								
byte	2 ⁷	2 ⁶	2 ⁵	2 ⁴	2 ³	2 ²	2 ¹	2 ⁰
1	03 ₁₆							
2	T	result						
3	-				PI			

Meaning of bit B:

B = 0 Single AS-i slave or A-slave

B = 1 B-slave

10.3.5.12 Set permanent parameter (SET_PP)

With this call, a parameter value for the specified AS-i slave is configured. The value is stored permanently in the EEPROM of the gateway.

The configured parameter value is transferred only when the AS-i slave is activated after turning on the power supply on the AS-i/PROFIBUS Gateway.

Request								
byte	2 ⁷	2 ⁶	2 ⁵	2 ⁴	2 ³	2 ²	2 ¹	2 ⁰
1	43 ₁₆							
2	T	-	circuit					
3	-		B	slave address				
4	-				PP			

Response								
byte	2^7	2^6	2^5	2^4	2^3	2^2	2^1	2^0
1	43_{16}							
2	T	result						

10.3.5.13 Get permanent parameter (GET_PP)

With this call, a slave-specific parameter value stored on the EEPROM of the AS-i/PROFIBUS Gateway is read.

Request								
byte	2^7	2^6	2^5	2^4	2^3	2^2	2^1	2^0
1	01_{16}							
2	T	-	circuit					
3	-		B	slave address				

Response								
byte	2^7	2^6	2^5	2^4	2^3	2^2	2^1	2^0
1	01_{16}							
2	T	result						
3	-				PP			

Meaning of bit B:

B = 0 Single AS-i slave or A-slave

B = 1 B-slave

10.3.5.14 Set auto address enable (SET_AAE)

This call can enable or disable the "automatic address programming" function.

The AUTO_ADDR_ENABLE bit is stored permanently; in other words, it is retained after a warm/hot restart on the AS-i master.

Request								
byte	2^7	2^6	2^5	2^4	2^3	2^2	2^1	2^0
1	$0B_{16}$							
2	T	-	circuit					
3	Auto_Address_Enable							

Response								
byte	2^7	2^6	2^5	2^4	2^3	2^2	2^1	2^0
1	$0B_{16}$							
2	T	result						

10.3.5.15 Change slave address (SLAVE_ADDR)

With this call, the AS-i address of an AS-i slave can be modified.

This call is mainly used to add a new AS-i slave with the default address "0" to the AS-Interface. In this case, the address is changed from "AS-i slave address old" = 0 to "AS-i slave address new".

This change can only be made when the following conditions are fulfilled:

1. An AS-i slave with "AS-i slave address old" exists.
2. If the old AS-i slave address is not equal to 0, an AS-i slave with address "0" cannot be connected at the same time.
3. The "AS-i slave address new" must have a valid value.
4. An AS-i slave with "AS-i slave address new" must not exist.

 Note	When the AS-i slave address is changed, the AS-i slave is not reset, in other words, the output data of the AS-i slave are retained until new data are received at the new address.
--	---

Request								
byte	2 ⁷	2 ⁶	2 ⁵	2 ⁴	2 ³	2 ²	2 ¹	2 ⁰
1	0D ₁₆							
2	T	–	circuit					
3	–		B	source address				
4	–		B	target address				

Response								
byte	2 ⁷	2 ⁶	2 ⁵	2 ⁴	2 ³	2 ²	2 ¹	2 ⁰
1	0D ₁₆							
2	T	result						

Meaning of bit B:
 B = 0 Single AS-i slave or A-slave
 B = 1 B-slave

10.3.5.16 Write AS-i slave extended ID1 (WRITE_XID1)

With this call, the extended ID1 code of an AS-i slave with address "0" can be written directly via the AS-i cable. The call is intended for diagnostic purposes and is not required in the normal master mode.

The AS-i master passes the extended ID1 code on to the AS-i slave without any plausibility check.

Request								
byte	2 ⁷	2 ⁶	2 ⁵	2 ⁴	2 ³	2 ²	2 ¹	2 ⁰
1	3F ₁₆							
2	T	–	circuit					
3	–				xID1			
Response								
Byte	2 ⁷	2 ⁶	2 ⁵	2 ⁴	2 ³	2 ²	2 ¹	2 ⁰
1	3F ₁₆							
2	T	result						

10.3.6 Other commands

10.3.6.1 Overview of the commands

Values for command

see page	Command	Value	Meaning	Req Len	Res Len
page 106	Other commands				
page 107	IDLE	00 ₁₆	No request	2	2
page 108	READ_IDI	41 ₁₆	Read IDI	2	36
page 109	WRITE_ODI	42 ₁₆	Write ODI	34	2
page 109	READ_ODI	56 ₁₆	Read ODI	2	34
page 110	SET_OFFLINE	0A ₁₆	Set_Off-Line_Mode	3	2
page 111	SET_DATA_EX	48 ₁₆	Set_Data_Exchange_Active	3	2
page 111	BUTTONS	75 ₁₆	Disable Pushbuttons	3	2
page 111	FP_PARAM	7D ₁₆	„Functional Profile“ Param.	≥3	≥2
page 112	FP_DATA	7E ₁₆	„Functional Profile“ Data	≥3	≥2
page 112	EXT_DIAG	71 ₁₆	ExtDiag generation	6	2
page 113	RD_EXT_DIAG	7B ₁₆	Read ExtDiag Settings	2	7
page 114	INVERTER	7C ₁₆	Configure Inverter Slaves	12	4
page 114	MB_OP_CTRL_WR_FLAGS	0x85	Write Flags	≥5	2
page 115	MB_OP_CTRL_RD_FLAGS	0x86	Read Flags	4	≥3
page 115	RD_MFK_PARAM	0x59	Read SEW MFK21 Parameter	6	≥3

Issue date - 24.8.2007

Values for command

see page	Command	Value	Meaning	Req Len	Res Len
page 107	IDLE	00 ₁₆	No request	2	2
page 108	READ_IDI	41 ₁₆	Read IDI	2	36
page 109	WRITE_ODI	42 ₁₆	Write ODI	34	2
page 109	READ_ODI	56 ₁₆	Read ODI	2	34
page 110	SET_OFFLINE	0A ₁₆	Set_Off-Line_Mode	3	2
page 111	SET_DATA_EX	48 ₁₆	Set_Data_Exchange_Active	3	2
page 111	BUTTONS	75 ₁₆	Disable Pushbuttons	3	2
page 111	FP_PARAM	7D ₁₆	„Functional Profile“ Parameter	≥3	≥2
page 125	funcion 0E ₁₆	0E ₁₆	set display language	4	3
page 126	funcion 0F ₁₆	0F ₁₆	set safety input slave "interpretation data"	4	2
page 112	FP_DATA	7E ₁₆	„Functional Profile“ Data	≥3	≥2
page 116	funcion 00 ₁₆	00 ₁₆	slaves with released safety function, response contains EcFlags	3	8
page 117	funcion 0D ₁₆	0D ₁₆	slaves with released safety function, response doesn't contain EcFlags	3	6
page 118	funcion 02 ₁₆	02 ₁₆	"Safety at Work" monitor diagnosis	5	n
page 124	funcion 03 ₁₆	03 ₁₆	integrated AS-i sensors: Warnings	3	10
page 125	funcion 04 ₁₆	04 ₁₆	integrated AS-i sensors: Availability	3	6
page 126	funcion 0E ₁₆	0E ₁₆	read display language	3	3
page 127	funcion 0F ₁₆	0F ₁₆	read safety input slave "interpretation data"	3	4
page 127	funcion 10 ₁₆	10 ₁₆	read addresses of safety slaves	3	6
page 112	EXT_DIAG	71 ₁₆	ExtDiag generation	6	2
page 113	RD_EXT_DIAG	7B ₁₆	Read ExtDiag Settings	2	7
page 114	INVERTER	7C ₁₆	Configure Inverter Slaves	12	4
page 114	MB_OP_CTRL_WR_FLAGS	0x85	Write Flags	≥5	2
page 115	MB_OP_CTRL_RD_FLAGS	0x86	Read Flags	4	≥3
page 115	RD_MFK_PARAM	0x59	Read SEW MFK21 Parameter	6	≥3

10.3.6.2 IDLE

When the value of "command" is zero, no request will be fulfilled.

Request								
byte	2 ⁷	2 ⁶	2 ⁵	2 ⁴	2 ³	2 ²	2 ¹	2 ⁰
1	00 ₁₆							
2	T	-	circuit					

Response								
byte	2 ⁷	2 ⁶	2 ⁵	2 ⁴	2 ³	2 ²	2 ¹	2 ⁰
1	00 ₁₆							

Issue date - 24.8.2007

Response								
byte	2 ⁷	2 ⁶	2 ⁵	2 ⁴	2 ³	2 ²	2 ¹	2 ⁰
2	T	result						

10.3.6.3 Read input data image (READ_IDI)

With this call, the input data values of all AS-i slaves are read out of the AS-i/PROFIBUS Gateway in addition to the cyclic data exchange. Though the command READ_IDI transmits all execution control flags (byte 3 and byte 4).

Request								
byte	2 ⁷	2 ⁶	2 ⁵	2 ⁴	2 ³	2 ²	2 ¹	2 ⁰
1	41 ₁₆							
2	T	-	circuit					

Response								
byte	2 ⁷	2 ⁶	2 ⁵	2 ⁴	2 ³	2 ²	2 ¹	2 ⁰
1	41 ₁₆							
2	T	result						
3	-							Pok
4	OR	APF	NA	CA	AAv	AAAs	s0	Cok
5	-				slave 1A			
6	slave 2A				slave 3A			
...	...							
36	slave 30B				slave 31B			

- Pok Periphery_Ok
- S0 LDS.0
- AAAs Auto_Address_Assign
- AAv Auto_Address_Available
- CA Configuration_Active
- NA Normal_Operation_Active
- APF APF
- OR Offline_Ready
- Cok Config_Ok

10.3.6.4 Write output data image (WRITE_ODI)

With this call the output data values of all AS-i slaves are written in addition to the cyclic data exchange.

Request								
byte	2 ⁷	2 ⁶	2 ⁵	2 ⁴	2 ³	2 ²	2 ¹	2 ⁰
1	42 ₁₆							
2	T	–	circuit					
3	–				slave 1A			
4	slave 2A				slave 3A			
...			
34	slave 30B				slave 31B			

Response								
byte	2 ⁷	2 ⁶	2 ⁵	2 ⁴	2 ³	2 ²	2 ¹	2 ⁰
1	42 ₁₆							
2	T	result						

10.3.6.5 Read output data image (READ_ODI)

With this call, the output data values of all AS-i slaves is being read out of the AS-i/PROFIBUS Gateway.

Request								
byte	2 ⁷	2 ⁶	2 ⁵	2 ⁴	2 ³	2 ²	2 ¹	2 ⁰
1	56 ₁₆							
2	T	–	circuit					

Response								
byte	2 ⁷	2 ⁶	2 ⁵	2 ⁴	2 ³	2 ²	2 ¹	2 ⁰
1	56 ₁₆							
2	T	result						
3	–				slave 1A			
	slave 2A				slave 3A			
...			
34	slave 30B				slave 31B			

10.3.6.6 Set offline mode (SET_OFFLINE)

This call switches between online and offline mode.

The online mode is the normal operating state for the AS-i master. The following jobs are processed cyclically:

- During the data exchange phase, the fields of the output data are transferred to the slave outputs for all AS-i slaves in the LAS. The addressed AS-i slaves submit the values of the slave inputs to the master when the transfer was free of errors.
- This is followed by the inclusion phase in which existing AS-i slaves are searched and newly added AS-i slaves are entered in the LDS or LAS.
- In the management phase, jobs by the user such as writing parameters are executed.

In the offline mode, the AS-i/PROFIBUS Gateway processes jobs by the user only. (Jobs that involve the immediate addressing of an AS-i slave are rejected with an error). There is no cyclic data exchange with the AS-i slaves.

When offline, the AS-i circuit is in a safe state.

The OFFLINE = TRUE bit is not permanently stored; in other words, following a cold/warm restart, the AS-i/PROFIBUS Gateway is once again in the online mode.

Request								
byte	2^7	2^6	2^5	2^4	2^3	2^2	2^1	2^0
1	$0A_{16}$							
2	T	-	circuit					
3	Off-Line							

Response								
byte	2^7	2^6	2^5	2^4	2^3	2^2	2^1	2^0
1	$0A_{16}$							
2	T	result						

The master changes to the offline phase, if there is a 1 written in byte 3.

The master will change to online mode if there is a 0 written in byte 3.

10.3.6.7 Release data exchange (SET_DATA_EX)

Request								
byte	2 ⁷	2 ⁶	2 ⁵	2 ⁴	2 ³	2 ²	2 ¹	2 ⁰
1	48 ₁₆							
2	T	-	circuit					
3	Data_Exchange_Active							

Response								
byte	2 ⁷	2 ⁶	2 ⁵	2 ⁴	2 ³	2 ²	2 ¹	2 ⁰
1	48 ₁₆							
2	T	result						

10.3.6.8 BUTTONS

With this call, the use of the buttons can be enabled/disabled.

Request								
byte	2 ⁷	2 ⁶	2 ⁵	2 ⁴	2 ³	2 ²	2 ¹	2 ⁰
1	75 ₁₆							
2	T	-	circuit					
3	Buttons disabled							

Response								
byte	2 ⁷	2 ⁶	2 ⁵	2 ⁴	2 ³	2 ²	2 ¹	2 ⁰
1	75 ₁₆							
2	T	result						

10.3.6.9 FP_PARAM

This command is used for parametrization of "functional profiles".

The content of the request and response bytes depends on the called function see <chapter 10.4 "Functional profiles">.

Request								
byte	2 ⁷	2 ⁶	2 ⁵	2 ⁴	2 ³	2 ²	2 ¹	2 ⁰
1	7D ₁₆							
2	T	-	circuit					
3	function							
4	request byte 1							
...	...							
n	request byte n-3							

Issue date - 24.8.2007

Response								
byte	2^7	2^6	2^5	2^4	2^3	2^2	2^1	2^0
1	7D ₁₆							
2	T	result						
3	response byte 1							
...	...							
n	response byte n-2							

10.3.6.10 FP_DATA

This command is used for the data exchange with "functional profiles". The content of the request and response bytes depends on the called function see <chapter 10.4 "Functional profiles">.

Request								
byte	2^7	2^6	2^5	2^4	2^3	2^2	2^1	2^0
1	7E ₁₆							
2	T	-	circuit					
3	function							
4	request byte 1							
...	...							
n	request byte n-3							

Response								
byte	2^7	2^6	2^5	2^4	2^3	2^2	2^1	2^0
1	7E ₁₆							
2	T	result						
3	response byte 1							
...	...							
n	response byte n-2							

10.3.6.11 EXT_DIAG

With this call, the conditions when to set the ExtDiag bit can be selected.

Request								
byte	2^7	2^6	2^5	2^4	2^3	2^2	2^1	2^0
1	71 ₁₆							
2	T	-	circuit					
3	CF							
4	APF							
5	PF							
6	CS							

Issue date - 24.8.2007

Response								
byte	2 ⁷	2 ⁶	2 ⁵	2 ⁴	2 ³	2 ²	2 ¹	2 ⁰
1	71 ₁₆							
2	T	result						

- CF ExtDiag is set, if ConfigError = 1
- APF ExtDiag is set, if APF = 1
- PF ExtDiag is set, if PeripheryFault = 1
- CS ExtDiag is set, if LCS is not empty

10.3.6.12 RD_EXT_DIAG

With this call, the conditions when the ExtDiag bit is set can be read.

Request								
byte	2 ⁷	2 ⁶	2 ⁵	2 ⁴	2 ³	2 ²	2 ¹	2 ⁰
1	7B ₁₆							
2	T	-	circuit					

Response								
byte	2 ⁷	2 ⁶	2 ⁵	2 ⁴	2 ³	2 ²	2 ¹	2 ⁰
1	75 ₁₆							
2	T	result						
3	CF							
4	APF							
5	PF							
6	CS							
7	FD							

- CF ExtDiag is set by ConfigError = 1
- APF ExtDiag is set by APF = 1
- PF ExtDiag is set by PeripheryFault = 1
- CS ExtDiag is set, if LCS is not empty
- FD Diagnosis will be updated only if this is dictated by the PROFIBUS norm.
Diagnosis date are not up to date when in doubt.

10.3.6.13 Inverter

With this call, an AS-i slave for frequency inverters is switched from cyclical mode to the transmission mode of four 16-bit values, in order to operate again with the selected AS-i destination parameter.

Request								
byte	2^7	2^6	2^5	2^4	2^3	2^2	2^1	2^0
1	$7C_{16}$							
2	T	-	circuit					
3	slave address							
4	destination parameter							
5	value 1, high byte							
6	value 1, low byte							
7	value 2, high byte							
8	value 2, low byte							
9	value 3, high byte							
10	value 3, low byte							
11	value 4, high byte							
12	value 4, low byte							

Response								
byte	2^7	2^6	2^5	2^4	2^3	2^2	2^1	2^0
1	$7C_{16}$							
2	T	result						

10.3.6.14 Write Flag

Use this command to write the flag of a control program.

The control program of devices with control functions takes on data from the PB interface.

Request								
Byte	2^7	2^6	2^5	2^4	2^3	2^2	2^1	2^0
1	0x85							
2	T	-	circuit					
3	introductory address							
4	number n							
5	number 1							
...	...							
n	number n							

Response								
Byte	2^7	2^6	2^5	2^4	2^3	2^2	2^1	2^0
1	0x85							

Issue date: 24.8.2007

Response								
Byte	2 ⁷	2 ⁶	2 ⁵	2 ⁴	2 ³	2 ²	2 ¹	2 ⁰
2	T	result						

10.3.6.15 Read Flag

Use this command to read out the flags of a control program.

The control program of devices with control functions takes on data from the PB interface.

Request								
Byte	2 ⁷	2 ⁶	2 ⁵	2 ⁴	2 ³	2 ²	2 ¹	2 ⁰
1	0x86							
2	T	–	circuit					
3	introductory address							
4	number n							

Response								
Byte	2 ⁷	2 ⁶	2 ⁵	2 ⁴	2 ³	2 ²	2 ¹	2 ⁰
1	0x86							
2	T	result						
3	data 1							
...								
n	data n							

10.3.6.16 READ_MFK_PARAM

Use this command to read multiple commands of a SEW MFK21 slave.

Request								
Byte	2 ⁷	2 ⁶	2 ⁵	2 ⁴	2 ³	2 ²	2 ¹	2 ⁰
1	0x59							
2	T	–	circuit					
3	slave							
4	index high							
5	index low							
6	number (n)							

Response								
Byte	2 ⁷	2 ⁶	2 ⁵	2 ⁴	2 ³	2 ²	2 ¹	2 ⁰
1	0x59							
2	T	result						
3	prm byte (index)							
4	prm byte (index+1)							
n+2	prm byte (index+n-1)							

Issue date - 24.8.2007

10.4 Functional profiles

10.4.1 "Safety at Work" List 1

 Note	<p>This function has been implemented only for reasons of the downwards compatibility.</p> <p>By AS-i 3.0 Masters, the state of the "safety input slaves" is specified on the image of the input data (0000 released).</p>
--	--

Function: 00₁₆

List of "safety-directed input slaves" ("AS-i Safety at Work"), whose safety function is released.

Safety-directed input slaves have the profile S-7.B or S-0.B (IO = 0 or 7, ID = B, see chapter 10.3.5.4: Read Actual Configuration).

The "Safety at Work" list 1 is a bit list which contains a bit for each possible slave address (1 - 31). This list is written in the bytes 5 until 8 in the response of the command of the command interface. Additionally, the response contains the ec-flags of the AS-i master in the bytes 3 and 4 (see chapter 10.3.4.3: "Get Flags").

The bits of the "Safety at Work" list 1 are set if the safety function of the slave is activated (e.g. emergency button pressed). The bit is only set at security slaves when both contacts are released, otherwise the bits have the value 0. "Normal" (non-security) slaves also have the value 0.

Since the safety monitor is also being activated when a safety slave is missing or if the AS-i circuit is shut off (offline active), the ec-flags will also be transmitted. It is sufficient however to monitor the group error message Cok (configuration error). As long as no configuration error, the list of the "safety-directed input slaves" can be used.

Configured safety slaves which are not available, and available slaves sending a wrong coder order, will not be entered in this list.

With the bit "O", the sequence of the bits within the "Safety at Work" list 1 can be chosen.

Request								
byte	2 ⁷	2 ⁶	2 ⁵	2 ⁴	2 ³	2 ²	2 ¹	2 ⁰
1	7E ₁₆							
2	T	O	circuit					
3	00 ₁₆							

Response (if O ≡ 0)								
byte	2 ⁷	2 ⁶	2 ⁵	2 ⁴	2 ³	2 ²	2 ¹	2 ⁰
1	7E ₁₆							
2	T	result						
3	-							Pok
4	OR	APF	NA	CA	AAv	AAAs	S0	Cok

Issue date: 24.8.2007

Response (if O ≡ 0)								
byte	2 ⁷	2 ⁶	2 ⁵	2 ⁴	2 ³	2 ²	2 ¹	2 ⁰
5	7	6	5	4	3	2	1	-
6	15	14	13	12	11	10	9	8
7	23	22	21	20	19	18	17	16
8	31	30	29	28	27	26	25	25

Response (if O ≡ 1)								
byte	2 ⁷	2 ⁶	2 ⁵	2 ⁴	2 ³	2 ²	2 ¹	2 ⁰
1	7E ₁₆							
2	T	result						
3	-							Pok
4	OR	APF	NA	CA	AAv	AA _s	S0	Cok
5	-	1	2	3	4	5	6	7
...	...							
8	24	25	26	27	28	29	30	31

Cok Config_Ok
 S0 LDS.0
 AA_s Auto_Address_Assign
 AA_v Auto_Address_Available
 CA Configuration_Active
 NA Normal_Operation_Active
 APF APF
 OR Offline_Ready
 Pok Periphery_Ok

Example for O ≡ 0:

Configuration OK,
 periphery OK (no peripheral fault,
 2 safety slaves with released safety function,
 AS-Interface addresses 4 and 10
 1 safety slave with unreleased safety function,
 AS-Interface address 5.

Reponse: 7E 00 01 25 10 04 00 00

Function: 0D₁₆

There is a funktion **0D₁₆** in addition to the funktion **00₁₆** . The funktion **0D₁₆** has no EcFlags in the response. The response falls short for 2 bytes.

Request								
Byte	2 ⁷	2 ⁶	2 ⁵	2 ⁴	2 ³	2 ²	2 ¹	2 ⁰
1	7E ₁₆							
2	T	O	circuit					
3	0Dh							

Response (by O ≡ 0)								
Byte	2 ⁷	2 ⁶	2 ⁵	2 ⁴	2 ³	2 ²	2 ¹	2 ⁰
1	7E ₁₆							
2	T	response						
3	7	6	5	4	3	2	1	–
4	15	14	13	12	11	10	9	8
5	23	22	21	20	19	18	17	16
6	31	30	29	28	27	26	25	24

Response (by O ≡ 1)								
Byte	2 ⁷	2 ⁶	2 ⁵	2 ⁴	2 ³	2 ²	2 ¹	2 ⁰
1	7E ₁₆							
2	T	response						
3	–	1	2	3	4	5	6	7
4	8	9	10	11	12	13	14	15
5	16	17	18	19	20	21	22	23
6	24	25	26	27	28	29	30	31

10.4.2 "Safety at Work" Monitor diagnosis

Function: 02₁₆

Since the "Safety at Work" monitor can generate more than 32 Byte diagnosis data, these must be read with several command interface calls. The byte 5 declares the start index in the field of the diagnosis data.

If the start index is 0, new data is fetched from the monitor. Otherwise, the function will respond out of the memory; the data can be read consistently.

10.4.2.1 Setting of the AS-i diagnosis

 Note	<p>The function unsorted diagnosis is available only with monitors in the version 2.0 and higher.</p> <p>The function sorted diagnosis is available with all monitors.</p>
--	--

The setting of the AS-i diagnosis takes place in the window "*Information about monitor and bus*" of the configuration software **asimon** for the AS-i safety monitor.

- Call up the menu *Edit/Information about monitor and bus*

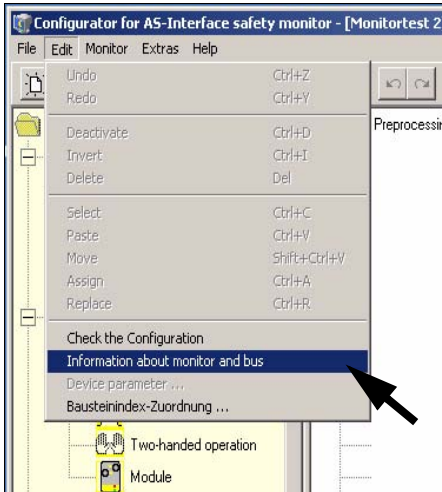

Fig. 1. Calling of *Information about monitor and bus*

- Set the function range in the window *Information about monitor and bus*

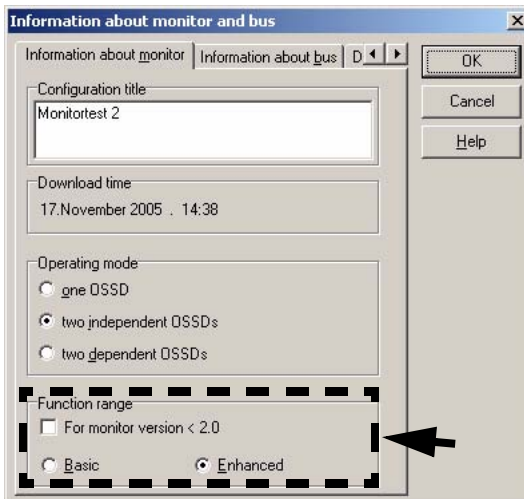

Fig. 2. Setting of function range

- Select in the window *Information about monitor and bus* the tab *Diagnosis/Service*

- Select within the range *Data selection sorted* (sorted by OSSD) or *unsorted* (all devices)

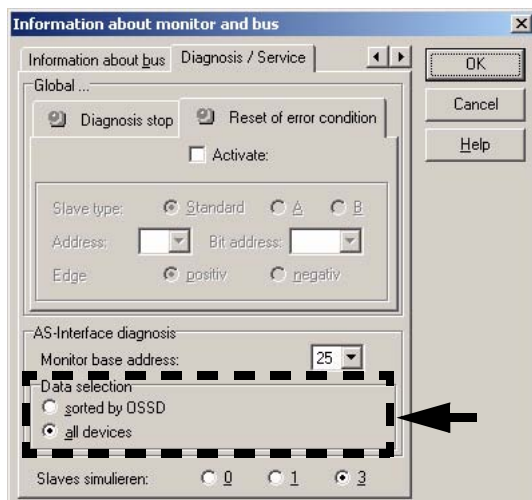

Fig. 3. Data selection (sorted/unsorted)

10.4.2.2 Enhanced diagnosis

Since the "Safety at Work" monitor diagnosis is longer than the maximum size of the command interface, it must be read with several adjacent requests.

The byte 5 ('index') declares the start index in the array of diagnostic data. If this start index is 0, the whole diagnosis is fetched from the monitor and stored to an internal buffer. Otherwise, the AS-i Master will respond out of the internal buffer. Thus, even though several requests are necessary to read the whole buffer, data integrity is maintained.

Request								
byte	2 ⁷	2 ⁶	2 ⁵	2 ⁴	2 ³	2 ²	2 ¹	2 ⁰
1	7E ₁₆							
2	T	L ¹	U ²	circuit				
3	02 ₁₆							
4	slave address							
5	index							

1. L=1 long diagnosis for advanced monitor
2. U=1 unsorted diagnosis (all devices)

Response								
byte	2 ⁷	2 ⁶	2 ⁵	2 ⁴	2 ³	2 ²	2 ¹	2 ⁰
1	7E ₁₆							
2	T	result						
3	diagnosis byte #index+0							
4	diagnosis byte #index+1							
...	...							
n	diagnosis byte #index+n-3							

The diagnosis array is set up as follows:

Safety Monitor Diagnosis Array								
"basic function range" and "sorted by OSSD"								
byte	2^7	2^6	2^5	2^4	2^3	2^2	2^1	2^0
0	00 ₁₆							
1	state of monitor							
2	state of OSSD1							
3	state of OSSD2							
4	number of devices not green, OSSD1							
5	number of devices not green, OSSD2							
6	device index 32, OSSD1							
7	color of device 32, OSSD1							
8	device index 33, OSSD1							
9	color of device 33, OSSD1							
...	...							
68	device index 63, OSSD1							
69	color of device 63, OSSD1							
70	device index 32, OSSD2							
71	color of device 32, OSSD2							
...	...							
132	device index 63, OSSD2							
133	color of device 63, OSSD2							

Safety Monitor Diagnosis Array								
"enhanced function range" and "sorted by OSSD"								
byte	2^7	2^6	2^5	2^4	2^3	2^2	2^1	2^0
0	00 ₁₆							
1	state of monitor							
2	state of OSSD1							
3	state of OSSD2							
4	number of devices not green, OSSD1							
5	number of devices not green, OSSD2							
6	device index 32, OSSD1							
7	color of device 32, OSSD1							
8	device index 33, OSSD1							
...	...							
133	color of device 95, OSSD1							
134	device index 32, OSSD2							
...	...							
261	color of device 95, OSSD2							

Issue date: 24.8.2007

Safety Monitor Diagnosis Array								
"basic function range" and "all devices"								
byte	2 ⁷	2 ⁶	2 ⁵	2 ⁴	2 ³	2 ²	2 ¹	2 ⁰
0	00 ₁₆							
1	state of monitor							
2	state of OSSD1							
3	state of OSSD2							
4	number of devices not green							
5	—							
6	device index 32							
7	color of device 32							
8	device index 33							
9	color of device 33							
...	...							
68	device index 63							
69	color of device 63							
70	device index 32							
71	assignment of device 32 to OSSD							
...	...							
132	device index 63							
133	assignment of device 63 to OSSD							

Safety Monitor Diagnosis Array								
"enhanced function range" and "all devices"								
byte	2 ⁷	2 ⁶	2 ⁵	2 ⁴	2 ³	2 ²	2 ¹	2 ⁰
0	00 ₁₆							
1	state of monitor							
2	state of OSSD1							
3	state of OSSD2							
4	number of devices not green							
5	—							
6	device index 32							
7	color of device 32							
8	device index 33							
...	...							
133	color of device 95							
134	device index 32							
135	assignment of device 32 to OSSD2							
...	...							
261	assignment of device 95 to OSSD							

Issue date - 24.8.2007

Possible assignment:

00₁₆: preprocessing

01₁₆: OSSD 1

02₁₆: OSSD 2

03₁₆: OSSD 1+2

80₁₆: device does not exist

See the "Safety at Work" monitor documentation for a description of the codes used for monitor state, OSSD state, device colors and assignments to OSSDs.

10.4.3 Integrated AS-i Sensors: Warnings

Function: 03₁₆

List of integrated AS-i sensors according to profile S-1.1 (without extended addressing) or profile S-3.A.1 (with extended addressing), by which the input data bit D1 ("Warning") being deleted.

For creating of this list CDI and IDI are used only. Integrated AS-i slaves which are projected but not existing therefore are not entered here.

Request								
byte	2 ⁷	2 ⁶	2 ⁵	2 ⁴	2 ³	2 ²	2 ¹	2 ⁰
1	7E ₁₆							
2	T	O	circuit					
3	03 ₁₆							

Response (if O ≡ 0)								
byte	2 ⁷	2 ⁶	2 ⁵	2 ⁴	2 ³	2 ²	2 ¹	2 ⁰
1	7E ₁₆							
2	T	result						
3	7A	6A	5A	4A	3A	2A	1A	0
...	...							
10	31B	30B	29B	28B	27B	26B	25B	24B

Response if O ≡ 1)								
byte	2 ⁷	2 ⁶	2 ⁵	2 ⁴	2 ³	2 ²	2 ¹	2 ⁰
1	7E ₁₆							
2	T	result						
3	0	1A	2A	3A	4A	5A	6A	7A
...	...							
10	24A	25A	26A	27A	28A	29A	30A	31A

10.4.4 Integrated AS-i sensors: Availability

Function: 04₁₆

List of the integrated slaves according to profile S-1.1 whose input data bits D2 ("Availability") are deleted.

For creating this list, CDI and IDI are used only. Integrated AS-i slaves which are projected but not existing therefore are not entered here.

Request									
byte	2 ⁷	2 ⁶	2 ⁵	2 ⁴	2 ³	2 ²	2 ¹	2 ⁰	
1	7E ₁₆								
2	T	O	circuit						
3	04 ₁₆								

Response (if O ≡ 0)								
byte	2 ⁷	2 ⁶	2 ⁵	2 ⁴	2 ³	2 ²	2 ¹	2 ⁰
1	7E ₁₆							
2	T	result						
3	7	6	5	4	3	2	1	0
...	...							
6	31	30	29	28	27	26	25	24

Response (if O ≡ 1)								
byte	2 ⁷	2 ⁶	2 ⁵	2 ⁴	2 ³	2 ²	2 ¹	2 ⁰
1	7E ₁₆							
2	T	result						
3	0	1	2	3	4	5	6	7
...	...							
6	24	25	26	27	28	29	30	31

10.4.5 Language-select

Function 0E₁₆

Use this function to set the display language.

Set:

Request								
Byte	2 ⁷	2 ⁶	2 ⁵	2 ⁴	2 ³	2 ²	2 ¹	2 ⁰
1	7D ₁₆							
2	T	-	circuit					
3	0E ₁₆							
4	language ¹							

1. Value: 0= default (no changes), 1= english, 2= german, 3= french, 4= italian, 5= spain.

Response								
Byte	2^7	2^6	2^5	2^4	2^3	2^2	2^1	2^0
1	7D ₁₆							
2	T	result						

Read:

Request								
Byte	2^7	2^6	2^5	2^4	2^3	2^2	2^1	2^0
1	7E ₁₆							
2	T	-	circuit					
3	0E ₁₆							

Response								
Byte	2^7	2^6	2^5	2^4	2^3	2^2	2^1	2^0
1	7E ₁₆							
2	T	result						
3	language ¹							

1. Value: 0= default (no changes), 1= english, 2= german, 3= french, 4= italian, 5= spanish.

10.4.6 Replacement of Safety Slaves input data

Function 0F₁₆

Use this function to replace safety slaves input data with "interpretation data". If the function is active, so have safety slaves input data the following meaning:

Bit 0,1: 00=channel 1 has released 11=channel 1 has not released.

Bit 2,3: 00=channel 2 has released, 11=channel 2 has not released.

 Note	This command replaces the old command MB_FP_LSS_ENABLE
--	--

Set:

Request								
Byte	2^7	2^6	2^5	2^4	2^3	2^2	2^1	2^0
1	7D ₁₆							
2	T	-	circuit					
3	0F ₁₆							
4	safety slaves ¹							

1. Value: 0= no substitute value, 1=substitute value for safety slaves

Issue date - 24.8.2007

Response								
Byte	2 ⁷	2 ⁶	2 ⁵	2 ⁴	2 ³	2 ²	2 ¹	2 ⁰
1	7D ₁₆							
2	T	result						

Read:

Request								
Byte	2 ⁷	2 ⁶	2 ⁵	2 ⁴	2 ³	2 ²	2 ¹	2 ⁰
1	7E ₁₆							
2	T	-	circuit					
3	0F ₁₆							

Response								
Byte	2 ⁷	2 ⁶	2 ⁵	2 ⁴	2 ³	2 ²	2 ¹	2 ⁰
1	7E ₁₆							
2	T	result						
4	safety slaves ¹							

1. Value: 0= no substitute value, 1=substitute value for safety slaves

10.4.7 List of Safety Slaves

Function 10₁₆

Use this function to find out the addresses of safety slaves.

Read:

Request								
Byte	2 ⁷	2 ⁶	2 ⁵	2 ⁴	2 ³	2 ²	2 ¹	2 ⁰
1	7D ₁₆							
2	T	O ¹	circuit					
3	10 ₁₆							

1. O = orientation

Response (by O = 0)								
Byte	2 ⁷	2 ⁶	2 ⁵	2 ⁴	2 ³	2 ²	2 ¹	2 ⁰
1	7D ₁₆							
2	T	result						
3	7	6	5	4	3	2	1	0
...	...							
6	31	30	29	28	27	26	25	24

Response (bei O ≡ 1)								
Byte	2 ⁷	2 ⁶	2 ⁵	2 ⁴	2 ³	2 ²	2 ¹	2 ⁰
1	7D ₁₆							
2	T	result						
3	0	1	2	3	4	5	6	7
...	...							
6	24	25	26	27	28	29	30	31

10.5 Command Interface examples

You can find actual command interface examples in the download area of the homepage.

10.5.1 Reading 16-bit input values

Command RD_7X_IN: Reading of 16-bit input values.

PROFIBUS DP V0: cyclic data exchange

Used ID/module in the GSD file: 12-byte management

Meaning of the bytes:

Request: RD_7X_IN	
Byte 1	50 _{hex} (RD_7X_IN)
Byte 2	00 _{hex} (master 1, single master)
Byte 3	1D _{hex} (slave address 29)
Byte 4	00 _{hex}
...	...
Byte 12	00 _{hex}

Response	
Byte 1	00 _{hex} (or old values)
Byte 2	00 _{hex} (or old values)
Byte 3	00 _{hex} (or old values)
Byte 4	00 _{hex} (or old values)
...	...
Byte 12	00 _{hex} (or old values)

The call of the command interface has not been answered with the valid values since the toggle bit has not been set.

Set of toggle bit:

Request	
Byte 1	50 _{hex}
Byte 2	80 _{hex} (toggle bit, result)
Byte 3	1D _{hex} (slave address 29)

Issue date - 24.8.2007

Request	
Byte 4	00 _{hex}
...	...
Byte 12	00 _{hex}

Result: See chapter 10.2.1 "Values for results"

Response	
Byte 1	50 _{hex}
Byte 2	80 _{hex} (toggle bit, master1)
Byte 3	16-bit channel 1 high byte _{hex}
Byte 4	16-bit channel 1 low byte _{hex}
Byte 5	16-bit channel 2 high byte _{hex}
Byte 6	16-bit channel 2 low byte _{hex}
Byte 7	16-bit channel 3 high byte _{hex}
Byte 8	16-bit channel 3 low byte _{hex}
Byte 9	16-bit channel 4 high byte _{hex}
Byte 10	16-bit channel 4 low byte _{hex}
Byte 11	00 _{hex} not used
Byte 12	00 _{hex} not used

To get the input data again, the T-bit has to be reset again. If a command of the command interface with DP V1 is being carried out, setting the toggle bit is not necessary.

10.5.2 Store current configuration to the AS-i master

1. Switch master to configuration mode
2. Write the current slave configuration to the master
3. Switch master to protected mode
4. Wait until master is in normal (protected) operation mode

12-byte management

1. Switch master to config mode

Request: SET_OP_MODE	
Byte 1	0C _{hex} (SET_OP_MODE)
Byte 2	00 _{hex} (T = 0, master 1, single master)
Byte 3	01 _{hex} (= config mode)
Byte 4	00 _{hex}
...	...
Byte 12	00 _{hex}

Issue date - 24.8.2007

Response	
Byte 1	00 _{hex} (or old values)
Byte 2	00 _{hex} (or old values)
...	...
Byte 12	00 _{hex} (or old values)

No result because toggle bit = 0.

Set the toggle bit:

Request: SET_OP_MODE	
Byte 1	0C _{hex} (SET_OP_MODE)
Byte 2	80 _{hex} (T = 1, master 1, single master)
Byte 3	01 _{hex} (= config mode)
Byte 4	00 _{hex}
...	...
Byte 12	00 _{hex}

Response	
Byte 1	0C _{hex}
Byte 2	80 _{hex} (T = 1, result = 0)
Byte 3	00 _{hex} (or old values)
...	...
Byte 12	00 _{hex} (or old values)

Master is now in configuration mode.

Result = 0 ⇒ No error, for other result codes see chapter 10.2.1 "Values for results".

2. Write the actual slave configuration to the master

Request: STORE_CDI	
Byte 1	07 _{hex} (STORE_CDI)
Byte 2	00 _{hex} (T = 0, master 1, single master)
Byte 3	00 _{hex}
...	...
Byte 12	00 _{hex}

Response	
Byte 1	00 _{hex} (or old values)
Byte 2	00 _{hex} (or old values)
...	...
Byte 12	00 _{hex} (or old values)

No result because toggle bit = 0.

Set the toggle bit:

Request: STORE_CDI	
Byte 1	07 _{hex} (STORE_CDI)
Byte 2	80 _{hex} (T = 0, master 1, single master)
Byte 3	00 _{hex}
...	...
Byte 12	00 _{hex}

Response	
Byte 1	00 _{hex}
Byte 2	80 _{hex} (T = 1, result = 0)
Byte 3	00 _{hex} (or old values)
...	...
Byte 12	00 _{hex} (or old values)

The current configuration data has been written.

3. Set master to protected mode

Request: SET_OP_MODE	
Byte 1	0C _{hex} (SET_OP_MODE)
Byte 2	00 _{hex} (T = 0, master 1, single master)
Byte 3	00 _{hex} (= protected mode)
Byte 4	00 _{hex}
...	...
Byte 12	00 _{hex}

Response	
Byte 1	00 _{hex} (or old values)
Byte 2	00 _{hex} (or old values)
...	...
Byte 12	00 _{hex} (or old values)

No result because toggle bit = 0.

Set the toggle bit:

Request: SET_OP_MODE	
Byte 1	0C _{hex} (SET_OP_MODE)
Byte 2	80 _{hex} (T = 1, master 1, single master)
Byte 3	00 _{hex} (= protected mode)
Byte 4	00 _{hex}
...	...
Byte 12	00 _{hex}

Response	
Byte 1	0C _{hex}
Byte 2	80 _{hex} (T = 1, result = 0)
Byte 3	00 _{hex} (or old values)
...	...
Byte 12	00 _{hex} (or old values)

The master has now been ordered to switch to the protected mode. It must be maintained now until the master changes into the operation mode.

4.Wait until master is in normal operation mode (and protected mode)

Reading out the flags until NA (Normal Operation Active) has been set.

Request: GET_FLAGS	
Byte 1	47 _{hex} (GET_FLAGS)
Byte 2	00 _{hex} (T = 0, master 1, single master)
Byte 3	00 _{hex}
...	...
Byte 12	00 _{hex}

Response	
Byte 1	00 _{hex} (or old values)
Byte 2	00 _{hex} (or old values)
...	...
Byte 12	00 _{hex} (or old values)

No result because toggle bit = 0.

Setting the toggle bit:

Request: GET_FLAGS	
Byte 1	47 _{hex} (GET_FLAGS)
Byte 2	00 _{hex} (T = 0, master 1, single master)
Byte 3	00 _{hex}
Byte 4	00 _{hex}
...	...
Byte 12	00 _{hex}

Response								
Byte 1	47 _{hex}							
Byte 2	80 _{hex} (T = 1, result = 0)							
Byte 3	-	-	-	-	-	-	-	POK
Byte 4	OR	APF	NA	CA	AAv	AA _s	S0	COK
Byte 5						AA _e	OL	DX
Byte 6	00 _{hex}							
...	...							
Byte 12	00 _{hex}							

The flag NA has to be set before the application is started. In case it is not set, the flags have to be read out until this flag has been set to 1.

The flag NA indicates that the master is in normal operation mode.

Normal operation mode is necessary to run the application safely.

10.5.3 Store new configuration for all slaves

1. Switch master in configuration mode
2. Write slave configuration to master
3. Write new list of projected slaves (*LPS*)
4. Write permanent parameter (*PP*) to master
5. Switch master to protected mode
6. Wait until master is in normal operation Mode (and protected mode)

12-byte management

1. Set master in config mode

Request: SET_OP_MODE	
Byte 1	0C _{hex} (SET_OP_MODE)
Byte 2	00 _{hex} (T = 0, master 1, single master)
Byte 3	01 _{hex} (= config mode)
Byte 4	00 _{hex}
...	...
Byte 12	00 _{hex}

Response	
Byte 1	00 _{hex} (or old values)
Byte 2	00 _{hex} (or old values)
Byte 3	00 _{hex} (or old values)
Byte 4	00 _{hex} (or old values)
...	...
Byte 12	00 _{hex} (or old values)

No result because toggle bit = 0.

Set the toggle bit:

Request: SET_OP_MODE	
Byte 1	0C _{hex} (SET_OP_MODE)
Byte 2	80 _{hex} (T = 1, master 1, single master)
Byte 3	01 _{hex} (= config mode)
Byte 4	00 _{hex}
...	...
Byte 12	00 _{hex}

Response	
Byte 1	0C _{hex}
Byte 2	80 _{hex} (T = 1, result = 0)
Byte 3	00 _{hex} (or old values)
Byte 4	00 _{hex} (or old values)
...	...
Byte 12	00 _{hex} (or old values)

The master is now in configuration mode.

Result: See chapter 10.2.1 "Values for results".

2. Write single configuration to master

Writing a configuration of an AS-i slave to the master.

For example:

16-bit input 4 CH at address 4 (Slave datasheet)

ID: 3_{hex}

ID2: E_{hex}

IO: 7_{hex}

ID1: F_{hex}

Request: SET_PCD	
Byte 1	25 _{hex} (SET_PCD)
Byte 2	00 _{hex} (T = 0, master 1, single master)
Byte 3	04 _{hex} (slave address to write to master)
Byte 4	EF _{hex} (ID + IO to configurate)
Byte 5	37 _{hex} (xID2 + xID1 to configurate)
Byte 6	00 _{hex}
...	...
Byte 12	00 _{hex}

Response	
Byte 1	00 _{hex} (or old values)
Byte 2	00 _{hex} (or old values)
Byte 3	00 _{hex} (or old values)
Byte 4	00 _{hex} (or old values)
...	...
Byte 12	00 _{hex} (or old values)

No result because toggle bit = 0.

Set the toggle bit:

Request: SET_PCD	
Byte 1	0C _{hex} (SET_PCD)
Byte 2	80 _{hex} (T = 1, master 1, single master)
Byte 3	04 _{hex} (slave address to write to master)
Byte 4	EF _{hex} (ID + IO to configurate)
Byte 5	37 _{hex} (ID + IO to configurate)
Byte 6	00 _{hex}
...	...
Byte 12	00 _{hex}

Response	
Byte 1	25 _{hex}
Byte 2	80 _{hex} (T = 1, result = 0)
Byte 3	00 _{hex} (or old values)
Byte 4	00 _{hex} (or old values)
...	...
Byte 12	00 _{hex} (or old values)

The single slave configuration for the 16-bit module is written.

This command must be repeated for all 31 A-slaves and all 31 B-slaves. If you don't connect a slave to an address, write F_{hex} for ID, IO, ID1, ID2.

3. Write new list of projected slaves

Write the complete LPS of your AS-i circuit.

Every bit in the LPS corresponds to one slave after the following scheme:

Byte0/Bit 0:slave 0/0A - can not be set!

Byte1/Bit 1:slave 1/1A

...

Byte3/Bit 7:slave 31/31A

Byte4/Bit 0:slave 0B - can not be set!

Byte4/Bit 1:slave 1B

...

Byte7/Bit 7:slave 31B

The slave is projected if the bit is set.

Example above: 16-bit module at address 4 \Rightarrow Set bit 4/byte 0:

Request: SET_LPS	
Byte 1	29 _{hex} (SET_LPS)
Byte 2	00 _{hex} (T = 0, master 1, single master)
Byte 3	00 _{hex}
Byte 4	10 _{hex} (LDS byte 0)
Byte 5	00 _{hex} (LDS byte 1)
...	...
Byte 11	00 _{hex} (LDS byte 7)
Byte 12	00 _{hex}

Response	
Byte 1	00 _{hex} (or old values)
Byte 2	00 _{hex} (or old values)
...	...
Byte 12	00 _{hex} (or old values)

No result because toggle bit = 0.

Setting the toggle bit:

Request: SET_LPS	
Byte 1	29 _{hex}
Byte 2	80 _{hex} (T = 1, master 1, single master)
Byte 3	00 _{hex}
Byte 4	10 _{hex} (LDS byte 0)
Byte 5	00 _{hex} (LDS byte 1)
...	...
Byte 11	00 _{hex} (LDS byte 7)
Byte 12	00 _{hex}

Response	
Byte 1	29 _{hex}
Byte 2	80 _{hex} (T = 1, result = 0)
Byte 3	00 _{hex} (or old values)
...	...
Byte 12	00 _{hex} (or old values)

The new list of protected slaves (LPS) is written.

4. Write permanent parameter (power on parameter) to master

Example as above: 16-bit module at address 4 with PP = 07_{hex}

Request: SET_PP	
Byte 1	43 _{hex} (SET_PP)
Byte 2	00 _{hex} (T = 0, master 1, single master)
Byte 3	04 _{hex} (slave address to write to master)
Byte 4	07 _{hex} (PP to write (use low nibble))
Byte 5	00 _{hex} (LDS byte 1)
...	...
Byte 12	00 _{hex}

Response	
Byte 1	00 _{hex} (or old values)
Byte 2	00 _{hex} (or old values)
...	...
Byte 12	00 _{hex} (or old values)

No result because toggle bit = 0

Setting the toggle bit:

Request: SET_PP	
Byte 1	43 _{hex} (SET_PP)
Byte 2	80 _{hex} (T = 0, master 1, single master)
Byte 3	04 _{hex} (slave address to write to master)
Byte 4	07 _{hex} (PP to write (use low nibble))
Byte 5	00 _{hex}
...	...
Byte 12	00 _{hex}

Response	
Byte 1	43 _{hex}
Byte 2	80 _{hex} (T = 1, Result = 0)
Byte 3	00 _{hex}
...	...
Byte 12	00 _{hex}

The permanent parameter for the 16-bit module is written.

This command must be repeated for all 31 A-slaves and all 31 B-slaves. If you don't connect a slave to an address, write the default value to the master (F_{hex}) as a permanent parameter.

5. Switch Master to Protected Mode

Request: SET_OP_MODE	
Byte 1	0C _{hex} (SET_OP_MODE)
Byte 2	00 _{hex} (T = 0, master 1, single master)
Byte 3	00 _{hex} (= protected mode)
Byte 4	00 _{hex}
...	...
Byte 12	00 _{hex}

Response	
Byte 1	00 _{hex} (or old values)
Byte 2	00 _{hex} (or old values)
...	...
Byte 12	00 _{hex} (or old values)

No result because toggle bit = 0.

Setting the toggle bit:

Request: SET_OP_MODE	
Byte 1	0C _{hex} (SET_OP_MODE)
Byte 2	80 _{hex} (T = 1, master 1, single master)
Byte 3	00 _{hex} (= protected mode)
Byte 4	00 _{hex}
...	...
Byte 12	00 _{hex}

Response	
Byte 1	0C _{hex}
Byte 2	80 _{hex} (T = 1, result = 0)
Byte 3	00 _{hex} (or old values)
...	...
Byte 12	00 _{hex} (or old values)

The master has now been ordered to switch to protected mode.

6. Wait until master is in normal (protected) operation mode

Read out the flags, until the NA (Normal Operation Active) has been set.

Request: GET_FLAGS	
Byte 1	47 _{hex} (GET_FLAGS)
Byte 2	00 _{hex} (T = 0, master 1, single master)
Byte 3	00 _{hex}
...	...
Byte 12	00 _{hex}

Response	
Byte 1	00 _{hex} (or old values)
Byte 2	00 _{hex} (or old values)
...	...
Byte 12	00 _{hex} (or old values)

No result because toggle bit = 0.

Setting the toggle bit:

Request: GET_FLAGS	
Byte 1	47 _{hex} (GET_FLAGS)
Byte 2	00 _{hex} (T = 0, master 1, single master)
Byte 3	00 _{hex}
Byte 4	00 _{hex}
...	...
Byte 12	00 _{hex}

Response								
Byte 1	47 _{hex}							
Byte 2	80 _{hex} (T = 1, result = 0)							
Byte 3	-	-	-	-	-	-	-	POK
Byte 4	OR	APF	NA	CA	AAv	AAs	S0	COK
Byte 5						AAe	OL	DX
Byte 6	00 _{hex}							
...	...							
Byte 12	00 _{hex}							

The flag NA has to be set before the application is started. In case it is not set, the flags have to be read out until this flag has been set to 1.

The flag NA indicates that the master is in normal operation mode.

Normal operation mode is necessary to run the application safely.

If a command of the command interface is used via PROFIBUS DP V1, it is not necessary to use the toggle bit.

The flag NA indicates that the master is in the normal operating mode which is necessary for the application to run safely.

11 Commissioning Tools

The Windows based software "AS-i Control Tools" is designed to make the commissioning of the AS-i/PROFIBUS Gateway so easy as possible.

The software communicates with the AS-i/PROFIBUS Gateway using a PROFIBUS DP Master Simulator DP V1.

11.1 Windows software AS-i Control Tools

The Windows software "AS-i Control Tools" enable you to configure the AS-i circuit in a very comfortable way.

1. For this purpose plug in the PROFIBUS DP Master Simulator DP V1 or a serial PROFIBUS Master to the D-SUB-connector of the AS-i/PROFIBUS Gateway and connect the device via the RS 232 interface with a fully covered cable to a serial interface of your PC.
2. Start the AS-i-Control-Tools.
3. Call the command Master | New.

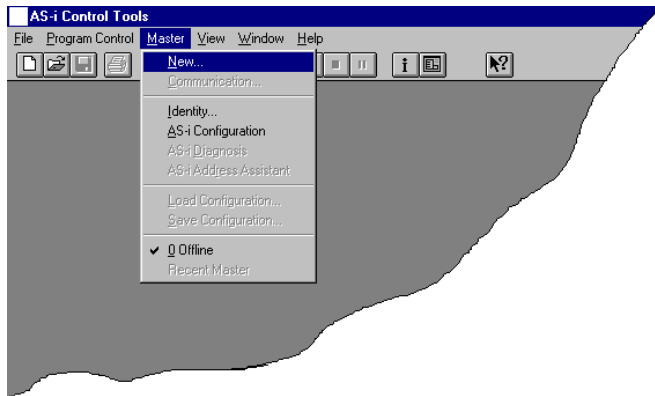

4. Choose PROFIBUS as protocol.

5. Do the appropriate settings. (e.g. serial interface, COM 1, station address AS-i circuit <1>)

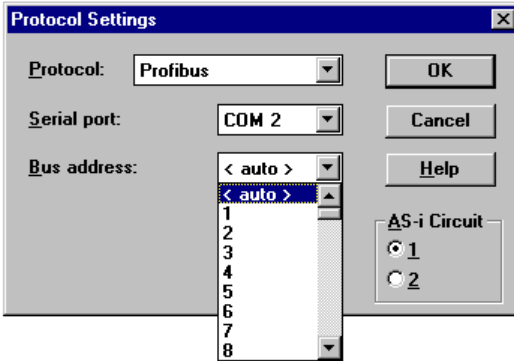

6. Call the command Master | AS-i configuration.
The AS-i configuration editor will be started. All detected and projected AS-i slaves are displayed in this window.

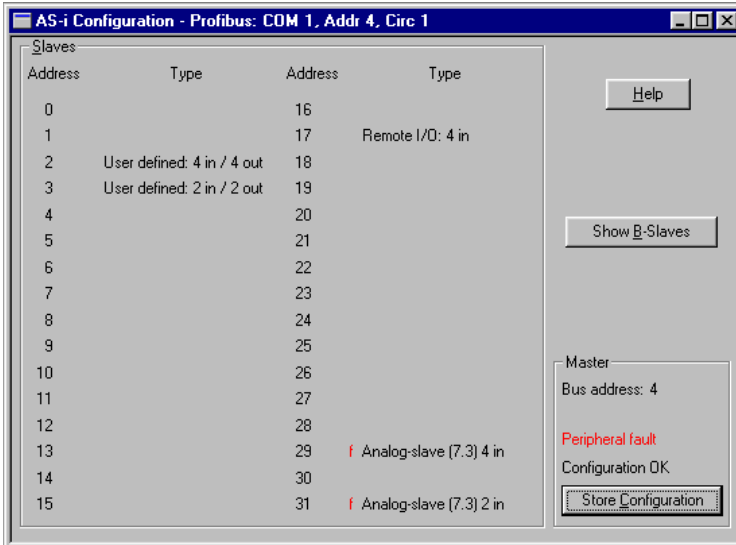

7. Click on a slave entry to open the dialog box slave configuration.

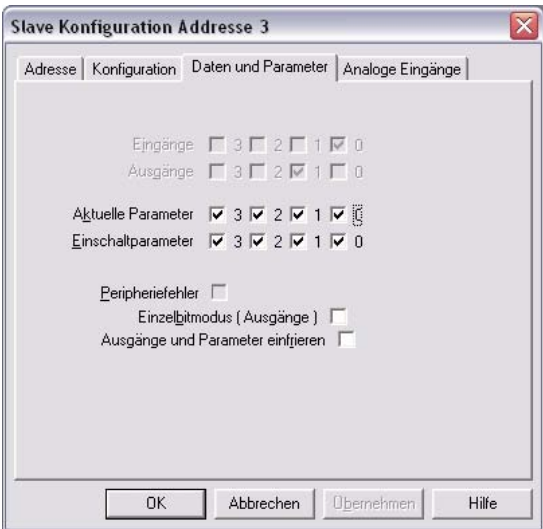

Changing a slave address, setting AS-i parameters or AS-i configuration data is possible here. Additionally, inputs and outputs can be tested.

8. Click in the main menu on the second button from the right side to acquire a graphic presentation of the "AS-i Control Tools".

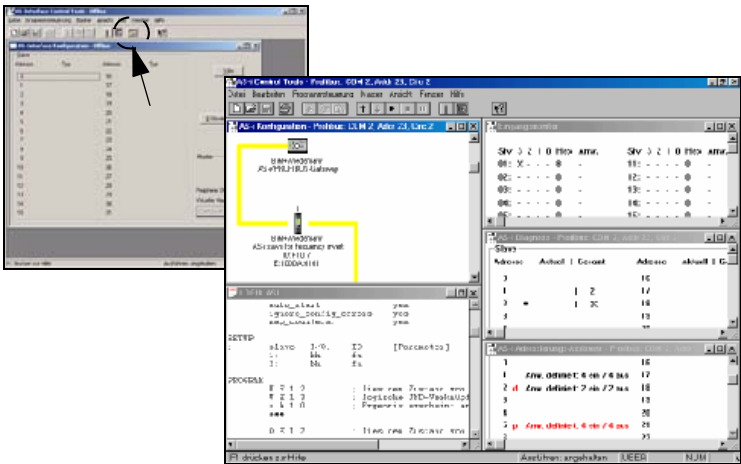

A very easy approach to configure the AS-i circuit is connecting each AS-i slave to the line and setting the AS-i slave address one after the other. After that press the button "Store configuration" to adopt the detected AS-i circuit to the AS-i master as projected data.

Furthermore you can use the **AS-i Address Assistant**. This tool automatically changes the address of an AS-i slave to the desired address after connecting the slave to the AS-i line. The desired AS-i configuration can be created offline before and then be stored to a file. When building up the plant you only have to connect the AS-i slaves to the AS-i line one after the other.

Further descriptions to all features of the software can be obtained from the integrated help.

11.1.1 PROFIBUS DP Master Simulator

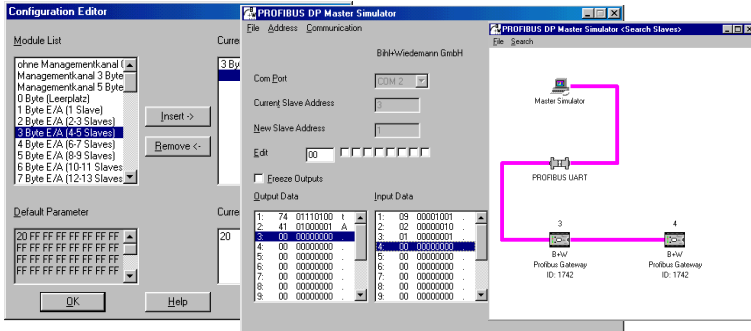

The PROFIBUS DP Master Simulator is an easy to use software for data exchange with PROFIBUS slaves of almost all manufacturers via PROFIBUS DP. The PROFIBUS DP master simulator can exchange data with many PROFIBUS slaves even without GSD file or type-file. The PROFIBUS slaves can be put into operation with the default I/O window. Input data can be read and output data can be written. Furthermore, the PROFIBUS DP Master Simulator also processes GSD-files. User parameters can be edited and the configuration can be modified and stored. The PROFIBUS station address can be changed with the PROFIBUS DP master simulator as well, this is useful for PROFIBUS I/O modules in protection class IP67 without addressing switches.

The PROFIBUS DP Master Simulator offers the possibility to scan a PROFIBUS network for connected slaves and to display them graphically. In this case, the case the PROFIBUS UART has to be connected directly to a PROFIBUS slave. The I/O data and the PROFIBUS user diagnosis can be displayed binary, hexadecimal and now also as ASCII code. The PROFIBUS output data can be transmitted consistently to the PROFIBUS slave. In **type mode** it is possible to set an output as long as the mouse button is pressed.

The new version of the PROFIBUS DP Master Simulator supports PROFIBUS DP V1. PROFIBUS slaves can be operated in the acyclic mode DP V1. This is especially helpful for commissioning complex field devices like drives, modular I/O systems etc.

The PROFIBUS Master Simulator consists of the software and the **PROFIBUS UART** which is the ideal interface converter between the RS 232 interface of a PC and the PROFIBUS slave. The **UART** does not need any additional external power supply. Therefore it is also suitable for mobile use with a laptop or a notebook. The

Issue date - 24.8.2007

PROFIBUS UART is simply inserted between the PROFIBUS slave and the RS 232 connector cable.

Besides the software "PROFIBUS DP master simulator", **DLL drivers** for Windows98, Windows Me, Windows 2000 and Windows NT as well as examples written in C come with the PROFIBUS UART. This offers the possibility to **use the PROFIBUS UART in combination with an own software**. However the PROFIBUS UART is a monitoring and commissioning tool for PROFIBUS slaves, it is not designed to control automation processes.

12 Appendix: Example for startup on a Siemens S7

This example shows you how to start up the AS-i/PROFIBUS-Gateway stainless steel version VBG-PB-K20-DMD on a Siemens S7-300 programmable logic controller.

Hardware used:

SIMATIC S7 power supply	PS 307 5A
SIMATIC S7-CPU with PROFIBUS DP	CPU 315-2DP
	Order No.: 6ES7 315-2AF03-0AB0
	Firmware Version 1.2
AS-i/PROFIBUS-Gateway in stainless steel	VBG-PB-K20-DMD
AS-i-Power-Extender	
AS-i-4E Module	
AS-i-4E Module	
Power supply	Powers the AS-i components through the AS-i Power Extender

Software used:

GSD-File for the AS-i/PROFIBUS-Gateway in stainless steel VBG-PB-K20-DMD

SIMATIC Step7 Version 5.2 Service Pack 1 Version: K5.2.1.0

Associated documentation:

AS-i/PROFIBUS-Gateway Operating Manual

SIEMENS S7-300 documentation

12.1 Hardware configuration

12.1.1 Electrical connection for AS-i

To supply the AS-i circuit, connect the output on the AS-i Power Extender or an AS-i power supply to the AS-i/Profibus-Gateway. Observe correct polarity of the terminals AS-i(+) and AS-i(-).

In the following the desired AS-i slaves are connected to the AS-i circuit.

The AS-i slaves have their device address set to 0 by default. This must be changed to the desired AS-i slave address.

You can set the AS-i slave address using the function "AS-INTERFACE SLAVE ADDR" function from the submenu "SETUP" on the AS-i/Profibus Gateway. For more detailed information, refer to chapter 6.

Once the AS-i circuit has been configured and parameterized as desired, apply this configuration to the AS-i/PROFIBUS Gateway using the function "QUICK SETUP".

The AS-i/PROFIBUS-Gateway is now ready to run.

12.1.2 Electrical connection for PROFIBUS-DP

To connect the AS-i/PROFIBUS-Gateway to the CPU 315-2DP, a standard PROFIBUS cable with 9-pin SUB-D plug is used.

If the AS-i/PROFIBUS Gateway is connected on the PROFIBUS as the last station, the termination resistor on the PROFIBUS plug must be enabled.

12.2 SIMATIC Step Configuration

The remainder of this description presumes that a SIMATIC Step7 project has been created and added to an S7-300.

Now the hardware configuration must be opened for this SIMATIC-300 station.

12.2.1 Configuration of the Hardware

Before configuring the hardware, the GSD file VBG-PB-K20-DMD 576 A1745.gsd supplied with the AS-i/PROFIBUS Gateway must be added to the hardware catalog.

Add the GSD file using the menu function "Install new GSD".



The PROFIBUS properties of the AS-i/PROFIBUS-Gateway are described in the GSD file VBG-PB-K20-DMD 576 A1745.gsd.

Clicking on the "Open" field adds the GSD file VBG-PB-K20-DMD 576 A1745.gsd to the hardware catalog.

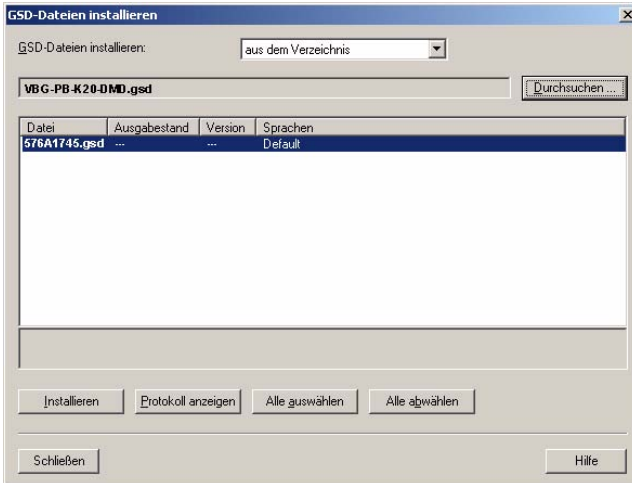

Clicking on the "Open" field adds the GSD file VBG-PB-K20-DMD 576 A1745.gsd to the hardware catalog.

After successful installation of the GSD file you may now open the hardware catalog. The modules contained under SIMATIC 300.

1. profile rail
2. power supply e.g. PS 307 5A
3. CPU e.g. CPU 315-2 DP

are added to the project. When selecting the CPU module, note the correct hardware version (identifiable by the imprint of the part number at lower left) and the firmware version (identifiable at left beneath the cover).

Steckplatz	Baugruppe	Bestellnummer	Firmware	MPI-Adresse	E-Adresse	A-Adresse
1	PS 307 5A	6ES7 307-1EA00-0AA0				
2	CPU 315-2 DP	6ES7 315-2AF03-0AB0	V1.2	2		
3	DP				1023*	

When adding the CPU module you are prompted for the desired PROFIBUS connection. The standard proposed is for the CPU as PROFIBUS-DP Master. This can be directly applied. The CPU mode must be set on the DP Master.

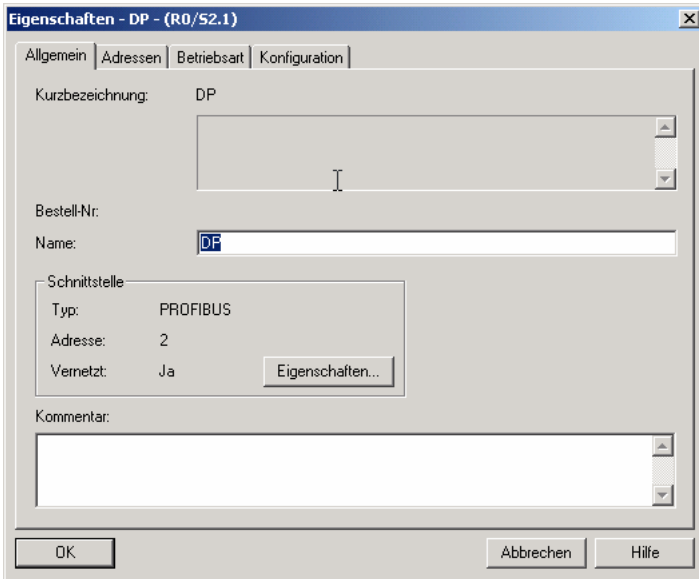

The CPU PROFIBUS-DP Properties can be used to display the properties for the PROFIBUS. Clicking on the "Settings" button displays the PROFIBUS settings.

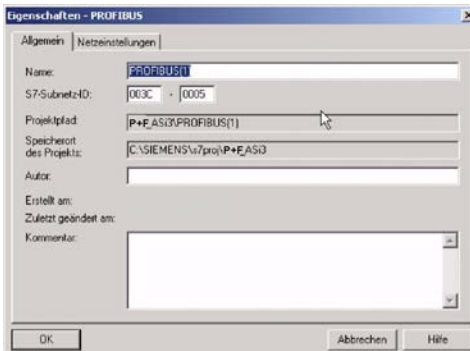

Profile "DP" is generally used as the PROFIBUS profile.

The bit rate for the PROFIBUS can be set in the window "Properties-PROFIBUS" ® "Network settings" ® "Transmission rate".

If special adjustments are needed, you can adjust the PROFIBUS parameters using the profile "Properties-PROFIBUS" @ "Network settings" @ "Profile" @ "User defined".

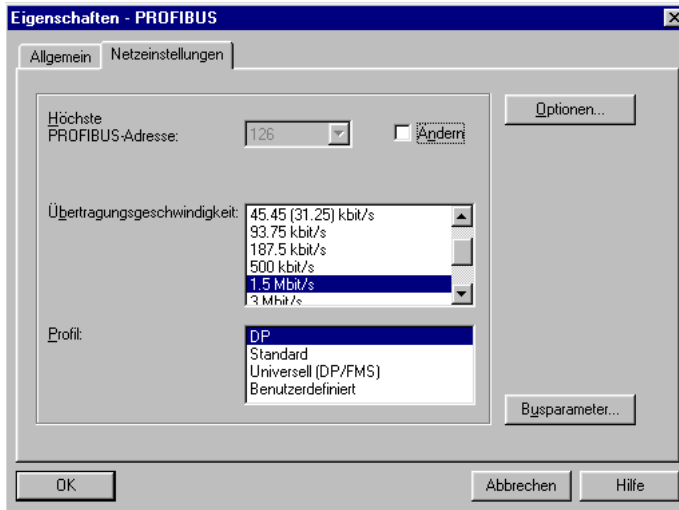

12.2.2 Insert AS-i/PROFIBUS Gateway

Once the SIMATIC hardware has been added to the hardware configuration and the PROFIBUS configured, you can add the AS-i/PROFIBUS-Gateway to the project.

After successfully installing the GSD file 576 A1745.gsd you will find the AS-i/PROFIBUS-Gateway in the hardware catalog under PROFIBUS/Other FIELD DEVICES/Gateway/AS-i.

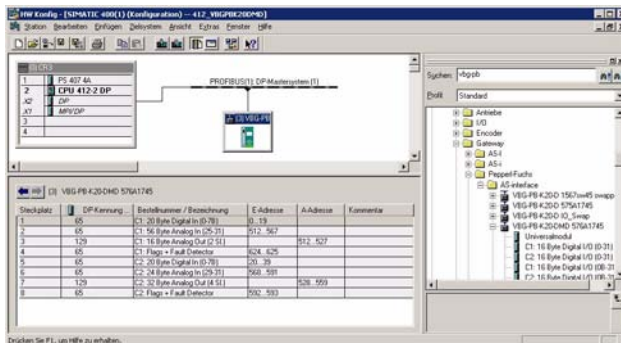

The AS-i/PROFIBUS-Gateway is called VBG-PB-K20-DMD 576 A1745 in the catalog and can now be added to the PROFIBUS branch using drag and drop.

Opening the device VBG-PB-K20-DMD 576 A1745 by clicking on the plug sign in the hardware catalog causes a list to appear of the possible PROFIBUS communication modules.

Which module you select for the desired PROFIBUS communication depends on which version of the AS-i circuit you have and on the desired communication possibilities.

For simple transmission of the data bits in an AS-i circuit with AS-i standard sensors in the I/O area of the SIMATIC CPU, use the module "16 Bite Digital In/Out (0-31)". With this module the input and output data for the possible 31 slaves in an AS-i circuit are send directly to the I/O section of the CPU.

When using A/B slaves, use the module "32 Byte Digital In/Out (0-31B)". The B-addressed slaves are mapped in the additional 15 bytes of data.

The other modules called "Digital" can be used instead of the above mentioned module to adapt to the actual AS-i circuit. This makes flexible adaptation to the structure of the AS-i circuit possible.

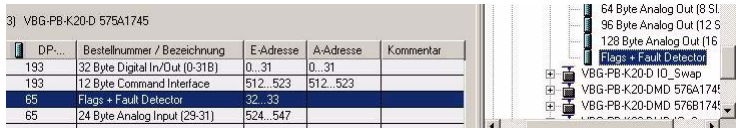
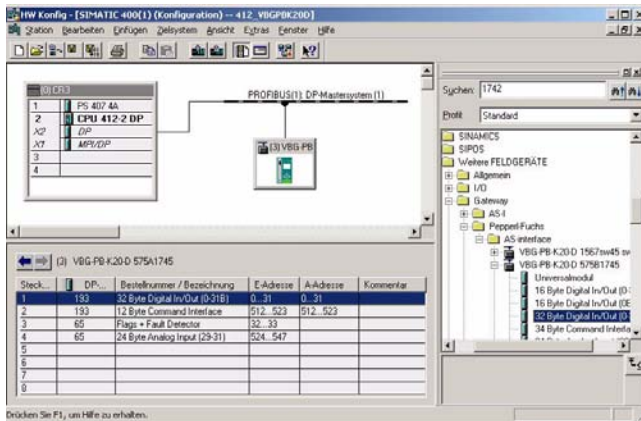

In addition to sending the AS-i slave digital data, a communication interface module can be added. The communication interface is used for sending specific commands to the AS-i/PROFIBUS-Gateway. More details about this can be found in chapter 7.

In order to send the analog values for AS-i slaves directly, the modules can be used with the keyword "Analog". The value in parentheses indicates which address range is to be used for the AS-i Analog slaves.

For modules "nn Byte Analog In (n Sl.)" and "nn Byte Analog Out (n Sl.)" the AS-i address of the analog slave can be freely selected.

When adding the AS-i/PROFIBUS-Gateway VBG-PB-K20-DMD 576 A1745 using drag and drop the dialog for assigning the PROFIBUS slave address is shown. The factory default setting for the AS-i/PROFIBUS-Gateway is Address 3.

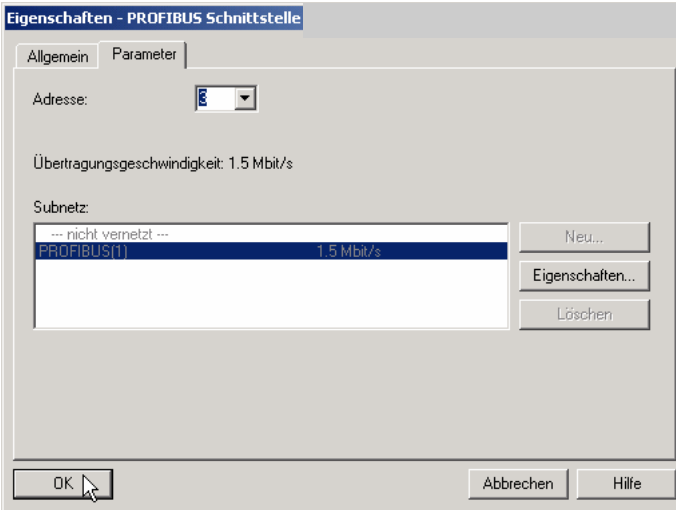

12.2.3 Configuring AS-i/PROFIBUS-Gateway in-/output

If the AS-i/PROFIBUS-Gateway is added to the PROFIBUS using drag and drop, the Step7 hardware configuration shows the following graphic.

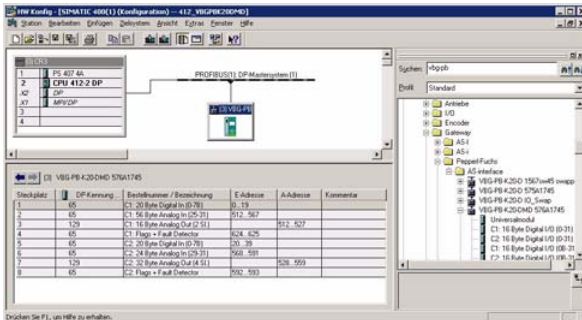

At this point the desired PROFIBUS communication module should be parameterised. This is done in the following steps:

1. Select the AS-i/PROFIBUS-Gateway by clicking on the Slave icon. In the lower edge of the screen a table is shown which contains lines beginning with Slot 0.
2. Select the desired communication module "Flags + Fault Detector" from the hardware catalog. These flags use the individual bits to signal the operating status of the AS-i/PROFIBUS Gateway and should be processed in the application program.

AS-i/PROFIBUS-Gateway

Appendix: Example for startup on a Siemens S7

3. Drag the selected communication module to the table line for Slot 0.

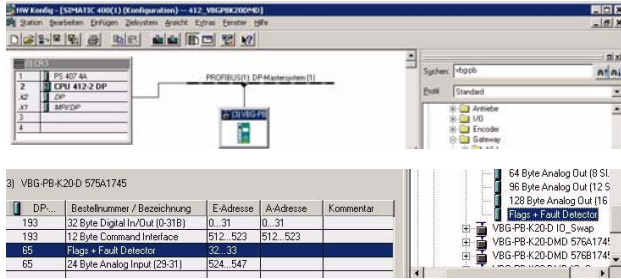

4. Select the desired communication module from the hardware catalog. Here "20 Byte Digital In/Out (0-31)"

5. Drag the selected communication module to the table line for slot 0.

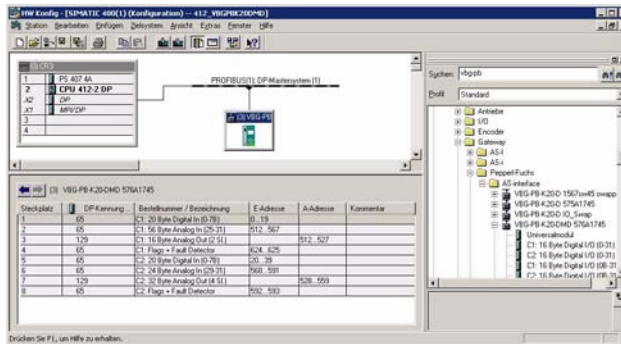

6. If desired, you can now place additional modules for the command interface and

Issue date - 24.8.2007

analog value transmission in the following slots:

Steckplatz	DP-Kennung	Bestellnummer / Bezeichnung	E-Adresse	A-Adresse	Kommentar
1	65	C1: 20 Byte Digital In (0-78)	0...19		
2	65	C1: 16 Byte Analog In (25-31)	512...567		
3	129	C1: 16 Byte Analog Out (2-51)		512...527	
4	65	C1: Flags + Fault Detector	624...625		
5	65	C2: 20 Byte Digital In (0-78)	20...39		
6	65	C2: 24 Byte Analog In (25-31)	568...591		
7	129	C2: 32 Byte Analog Out (4-51)		528...559	
8	65	C2: Flags + Fault Detector	552...593		

7. Double-clicking on the desired slot line opens a dialog window in which you can assign the PROFIBUS communication module to the address range of the CPU.

12.2.4 AS-i/PROFIBUS Gateway PROFIBUS DP parameters

The AS-i/PROFIBUS-Gateway is symbolically represented as a rectangular window connected with the PROFIBUS branch.

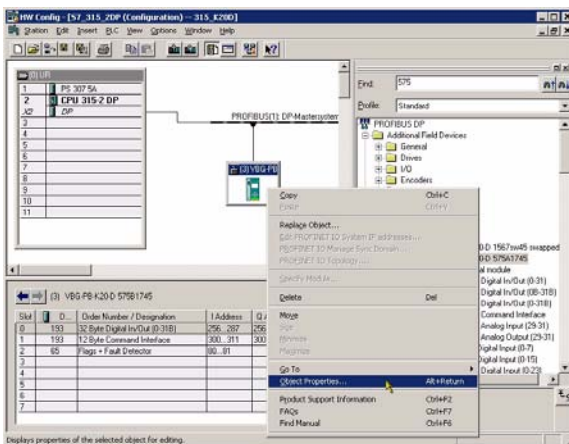

The diagnostics address entered in this window is used for parameterizing the function module SFC13 (diagnostic request). At this address you can use the standard function SFC13 to read out the PROFIBUS diagnostic data of this DP slave while running.

When invoking SFC13, note that the diagnostic address must be parameterized as a hexadecimal value.

For example: Diagnostic address 1022 @ W#16#3FE

Clicking on the "Parameterize" tab displays the possible settings for the PROFIBUS start parameters.

12.2.4.1 General DP parameters

Startup when nominal configuration is not the same as actual configuration:

Use this parameter to specify whether the AS-i circuit should be started up even if the AS-i circuit has a different configuration than the stored AS-i configuration.

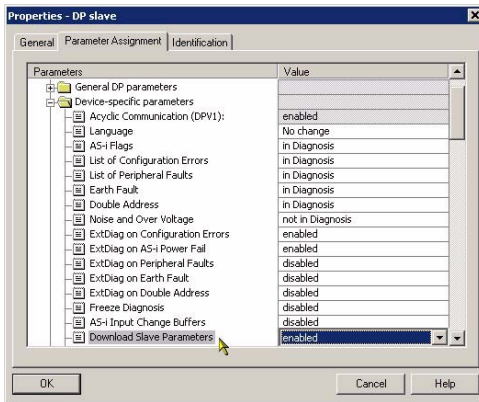

12.2.4.2 Device-specific parameters

Acyclic Communication

Turning acyclic PROFIBUS-DP communication on/off according to the DPV1 standard.

Default: Communication turned on according to DPV1.

AS-i Flags

Specifies whether the AS-i flags are sent in the PROFIBUS diagnostic.

Default: Transmission in the PROFIBUS diagnostic data.

List of Configuration Errors

The AS-i/DP Gateway saves a list of all AS-i slaves which have triggered a present configuration error. This list can be sent with the PROFIBUS diagnostic data.

Default: Transmission in the PROFIBUS diagnostic data.

List of Peripheral Faults

The AS-i/DP Gateway saves a list of all AS-i slaves which have triggered a peripheral errors. This list can be sent with the PROFIBUS diagnostic data.

Default: Transmission in the PROFIBUS diagnostic data.

Earth Fault

The AS-i/DP-Gateway can detect an earth (ground) fault. The information as to whether there is or is not an earth fault is sent in the diagnostic data.

Default: Transmission in the PROFIBUS diagnostic data.

Double Address

The AS-i/DP-Gateway detects when there is double addressing. This list can be sent with the diagnostic data.

Default: Transmission in the PROFIBUS diagnostic data.

Noise and Over voltage

The AS-i/DP-Gateway analyzes the quality of the AS-i voltage during running. This assessment can be sent with the diagnostic data.

Default: Not transmitted in the PROFIBUS diagnostic data.

ExtDiag on Configuration Errors

When an AS-i configuration error occurs, the AS-i/DP-Gateway sets the ExtDiag flag in its PROFIBUS data reply. By setting this flag the Profibus-DP slave tells the PROFIBUS master that there is an error condition and that the diagnostic data are being updated.

In the case of the S7 controller invoking of the OB82 is triggered when an ExtDiag flag is set. If the latter is not present, the controller is stopped.

Setting this ExtDiag flag can be suppressed using this parameter. Consequently no interrupt controlled OB82 invoking is triggered in the controller, and the controller must then respond to a possible AS-i configuration error by checking the AS-i flag in the input data.

Default: Setting of the ExtDiag flag for AS-i configuration error is enabled.

ExtDiag on AS-i Power Fail

Activates and deactivates setting of the ExtDiag flag on AS-i power fail.

Default: Setting of the ExtDiag flag on AS-i power fail is enabled.

ExtDiag on Peripheral Faults

Activates and deactivates setting of the ExtDiag flag on peripheral faults.

Default: Setting of the ExtDiag flag on peripheral faults disabled.

ExtDiag on Earth Fault

Activates and deactivates setting of the ExtDiag flag on earth (ground) fault.

Default: Setting of the ExtDiag flag on earth fault is disabled.

ExtDiag on Double Address

Activates and deactivates setting of the ExtDiag flag on double address.

Default: Setting of the ExtDiag flag on double address is disabled.

Freeze Diagnosis

The diagnostic data are continuously updated during runtime. If this is not desired, this parameter can be used to disable continuous updating. Updating then takes place only when this is required by the PROFIBUS standard.

AS-i Input Change Buffers

Default: Disabled.

Download Slave Parameters

Based on this entry the parameter bits can be downloaded for each AS-i slave. These are then sent to the connected AS-i slave when the AS-i cycle is started. Sending of the set parameters bits can be disabled with this value.

Default: Sending of the AS-i parameter bits enabled.

AS-i-Parameter Slave 1/1A...

The parameter bits send to this AS-i slave can be selected in the drop down window. The settings which are made with the parameters bits can be found in the data sheet for the corresponding slave.

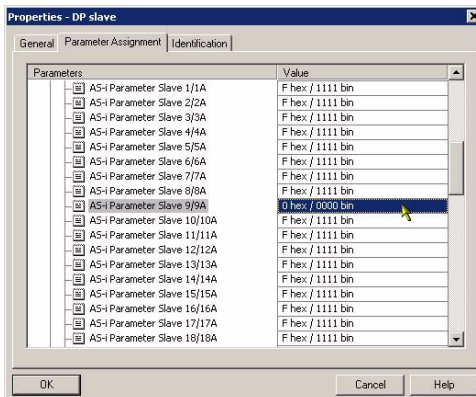

12.2.4.3 Hex parameterizing

DPV1_Status

Hexadecimal representation of the data resulting from the settings for parameter bytes 0 to 2.

User_Prm_Data

Hexadecimal representation of the data resulting from the settings for parameter bytes 3 to 37.

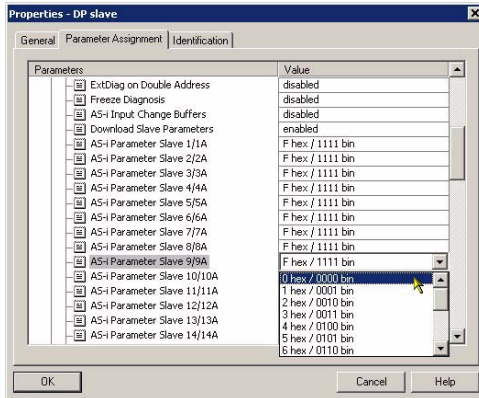

12.2.5 SIMATIC StepS7 blocks

After the hardware has been configured, these can be sent to the CPU. Since data transmission of the AS-i data is done in this example directly to the process image, no additional Step7 program is needed for data refreshing. Therefore there is no program code in OB1.

- OB1 Cyclical program block Access to the AS-i data is via the parameterized address space in the in-/outputs process image.
- OB82 PROFIBUS diagnostic alarm. This OB is invoked as soon as a PROFIBUS slave has set the ExtDiag flag in the telegram reply. This ExtDiag flag allows a PROFIBUS slave to report an error condition to a PROFIBUS master. If OB82 is not present, the CPU is stopped when a PROFIBUS slave sets the ExtDiag flag.
- OB86 PROFIBUS peripheral error. This OB is invoked when the PROFIBUS master detects a PROFIBUS slave failure.
- OB100 Startup OB. This OB is run once when the CPU starts up.

VAT_ASI_IOVariable table, AS-i startup example.

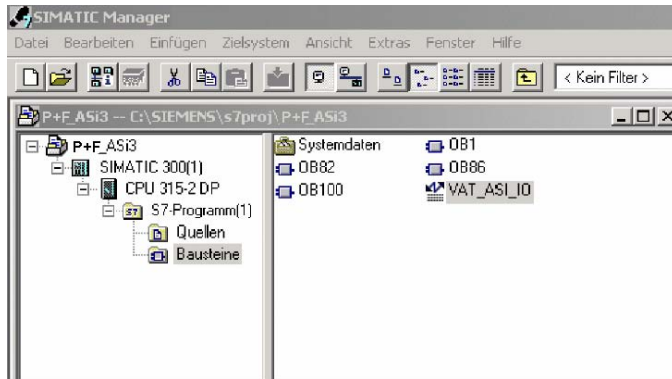

12.2.6 Variable table VAT_ASI_IO

In the hardware configuration the 16 bytes of I/O data for the AS-i/DP Gateway are coupled to the input/output byte Address 2 to 17 of the process image. The directly send AS-i diagnostic information for error processing are evident from the input bits of the EW0.

Flags + Fault Detector

Bit 0 = Konfigurationsfehler

Bit 1 = Slave with address ZERO detected

Bit 2 = Automatic addressing not possible

Bit 3 = Automatic addressing available

Bit 4 = Projecting mode active

Bit 5 = Not in normal mode

Bit 6 = AS-i-Power Fail

Bit 7 = AS-i-Master is offline

Bit 8 = Peripheral error

Bit 9 = reserved

Bit 10 = reserved

Bit 11 = reserved

Bit 12 = Earth fault

Bit 13 = Overvoltage

Bit 14 = Noise

Bit 15 = Double address

This allows the AS-i circuit data to appear directly in the process image inputs/outputs.

AS-Interface

Appendix: Example for startup on a Siemens S7

Operand	Symbol	Symbolkommentar	Anzahl	Statuswert
1	EB 2	"IN_Flags_Slave1"	Bit7-4=Flags Bit3-0=Slave1	BIN 2#0000_1000
2	EB 3	"IN_Slave2_Slave3"	Bit7-4=Slave2 Bit3-0=Slave3	BIN 2#0100_0000
3	EB 4	"IN_Slave4_Slave5"	Bit7-4=Slave4 Bit3-0=Slave5	BIN 2#0000_0000
4	EB 5	"IN_Slave6_Slave7"	Bit7-4=Slave6 Bit3-0=Slave7	BIN 2#0000_0000
5	EB 6	"IN_Slave8_Slave9"	Bit7-4=Slave8 Bit3-0=Slave9	BIN 2#0000_0000
6	E 2.4	"IN_ASI_Config_Error"	0=ConfigOK 1=ConfigError	BOOOL false
7	E 2.5	"IN_ASI_Power_Fail"	0=AS-i-PowerOK 1=AS-i-PowerError	BOOOL false
8	E 2.6	"IN_Periphery_Fault"	0=PeripheryOK 1=PeripherieError	BOOOL false
9	E 2.7	"IN_Configuration_Active"	0=ConfigActive 1=Configinactiv	BOOOL false
10				
11	AB 2	"OUT_Flags_Slave1"	Bit7-4=Flags Bit3-0=Slave1	BIN 2#0000_0000
12	AB 3	"OUT_Slave2_Slave3"	Bit7-4=Slave2 Bit3-0=Slave3	BIN 2#0000_0100
13	AB 4	"OUT_Slave4_Slave5"	Bit7-4=Slave4 Bit3-0=Slave5	BIN 2#0000_0000
14	AB 5	"OUT_Slave6_Slave7"	Bit7-4=Slave6 Bit3-0=Slave7	BIN 2#0000_0000
15	AB 6	"OUT_Slave8_Slave9"	Bit7-4=Slave8 Bit3-0=Slave9	BIN 2#0000_0000
16	A 2.4	"OUT_ASI_Off_Line"	0=OnLine 1=OffLine	BOOOL false
17	A 2.5	"OUT_LOS_Masterbit"	0=OffLine when ConfigError 1=active when ConfigError	BOOOL false
18	A 2.6	"OUT_Configuration_Mode"	-> Set Configuration Mode	BOOOL false
19	A 2.7	"OUT_Protected_Mode"	-> Set Protected Mode	BOOOL false
20				
21	EW 0	"Flags + Fault Detector"	AS-i Diagnose Information	BIN 2#0000_0000_0000_0000
22				

In the structure of the 16-byte I/O data field each AS-i slave has a 4-bit data field. This is determined by the address of the AS-i slave within the AS-i circuit.

Assignment of the I/O address and AS-i slave address		
Address byte	Bits 7 - 4	Bits 3 - 0
I/O byte 2	flags	slave 1
I/O byte 3	slave 2	slave 3
I/O byte 4	slave 4	slave 5
I/O byte 5	slave 6	slave 7
I/O byte 6	slave 8	slave 9
I/O byte 7	slave 10	slave 11
I/O byte 8	slave 12	slave 13
I/O byte 9	slave 14	slave 15
I/O byte 10	slave 16	slave 17
I/O byte 11	slave 18	slave 19
I/O byte 12	slave 20	slave 21
I/O byte 13	slave 22	slave 23
I/O byte 14	slave 24	slave 25
I/O byte 15	slave 26	slave 27
I/O byte 16	slave 28	slave 29
I/O byte 17	slave 30	slave 31

The data for the slaves present and projected in the AS-i circuit are refreshed based on their position in the I/O data field.

The data fields for non-present slaves are filled with zero.

This means for example the AS-i data for the AS-i slave having Address 12 occupy bits 7 - 4 in I/O byte 8 of the controller.

Issue date - 24.8.2007

12.2.6.1 AS-i flags byte 0, input bits 7 - 4

In order to check the current operating status of the AS-i circuit, the AS-i flags refreshed with each PROFIBUS cycle can be used. These for flags occupy bits 7 - 4 in input byte 0.

AS-i Config Error:

Bit 4: 0 = AS-i configuration OK, 1 = AS-i configuration faulty

If during running the gateway AS-i master detects a discrepancy between the nominal configuration and the actual configuration, this bit is set. This allows the control program to react to a faulty AS-i slave.

AS-i Power Fail

Bit 5: 0 = AS-i power OK, 1 = AS-i power fail

When there is a failure of the AS-i supply voltage, this is indicated by the AS-i power fail bit.

AS-i Peripheral Error

Bit 6: 0 = AS-I peripheral OK, 1 = AS-I peripheral error

This bit indicates that there is a peripheral error on an AS-i slave. This may result for example from incorrect parameterizing of the AS-i slave.

AS-i Configuration Active

Bit 7: 0 = AS-i configuration is active, 1 = AS-i configuration is inactive.

This bit indicates whether the AS-i gateway is in protected mode (Bit 7 = 0) or in projecting mode.

It is recommended that the AS-i flags be checked in the control program and to respond according to the reported states.



Note

It is recommended that the AS-i flags be checked in the control program and to respond according to the reported states.

12.2.6.2 AS-i flags byte 0, output bits 7 - 4

Output bits 7 - 4 in byte 0 can be used to affect the status of the AS-i circuit by the controller.

AS-i Off Line

Bit 4: 0 = Online, 1 = Offline

Use this bit to enable/disable the data cycle of the AS-i circuit. If the AS-i Master is in offline mode, no AS-i communication with the AS-i slaves will take place.

AS-i LOS Masterbit

Bit 5: 0 = Offline when AS-i configuration error disabled, 1 = enabled

If this bit is set, the AS-i Master immediately switches to the offline phase and stops AS-i communication when an AS-i configuration error is detected. This results in the connected AS-i output modules immediately switching to safe mode (outputs turned off).

AS-i Configuration Mode

Bit 6: 0 = no action, 1 = turn on configuration mode of AS-i Master

Setting Bit 6 switches the AS-i Master to configuration mode. Then for example the command interface can be used to save an existing AS-i configuration using the controller.

The rising edge is used for switching. After Bit 7 = 1 in the input flags has indicated that the AS-i Master is in configuration mode, output bit 6 must be reset again by the controller.

AS-i Protected Mode

Bit 6: 0 = no action, 1 = turn on protected mode of AS-i Master

After successful configuration of the AS-i Master through the command interface, the AS-i Master can be switched back to protected mode.

The rising edge is used for switching. After Bit 7 = 0 in the input flags has indicated that the AS-i Master is in configuration mode, output bit 7 must be reset again by the controller.

The table shows an AS-i circuit which is in operation. Since there is no AS-i error, Bits 4 - 7 in the input byte are ZERO.

In the case of AS-i Slave address 1, this is a 4 I/O module. In this module Output 3 is set and Input 1 allocated.

AS-i Slave address 2 is a 4 Input module. Input 2 is set.

@VAT_ASI_IO -- P+F_ASIASIMATIC 300(1)\CPU 315-2 DP\S7-Programm[1						
	↑	Operand	Symbol	Anzei	Statuswert	Steuerwert
1	EB	0	"IN_Flags_Slave1"	BIN	2#0000_0001	
2	EB	1	"IN_Slave2_Slave3"	BIN	2#0010_0000	
3	EB	2	"IN_Slave4_Slave5"	BIN	2#0000_0000	
4	EB	3	"IN_Slave6_Slave7"	BIN	2#0000_0000	
5	EB	4	"IN_Slave8_Slave9"	BIN	2#0000_0000	
6	E	0.4	"IN_ASI_Config_Error"	BOOL	false	
7	E	0.5	"IN_ASI_Power_Fail"	BOOL	false	
8	E	0.6	"IN_Periphery_Fault"	BOOL	false	
9	E	0.7	"IN_Configuration_Active"	BOOL	false	
10						
11	AB	0	"OUT_Flags_Slave1"	BIN	2#0000_0100	2#0000_0100
12	AB	1	"OUT_Slave2_Slave3"	BIN	2#0000_0000	
13	AB	2	"OUT_Slave4_Slave5"	BIN	2#0000_0000	
14	AB	3	"OUT_Slave6_Slave7"	BIN	2#0000_0000	
15	AB	4	"OUT_Slave8_Slave9"	BIN	2#0000_0000	
16	A	0.4	"OUT_ASI_Off_Line"	BOOL	false	
17	A	0.5	"OUT_LOS_Masterbit"	BOOL	false	
18	A	0.6	"OUT_Configuration_Mode"	BOOL	false	false
19	A	0.7	"OUT_Protected_Mode"	BOOL	false	false
20						

12.2.7 System behavior on AS-i Config Error

If while running in protected mode a configured AS-i slave fails, an AS-i configuration error is generated.

1. The missing slave is shown on the display of the AS-i/DP Gateway.
2. The input flag AS-i Config Error Bit 4 in Byte 2 is set.
3. If the standard parameters for the PROFIBUS hardware configuration were applied unchanged for the AS-i/PROFIBUS Gateway, the Gateway sets the ExtDiag flag in the PROFIBUS data reply. This results in the controller signaling a PROFIBUS slave error and invoking OB82. At the same time the event is written to the diagnostic buffer of the CPU.

If the message for the ExtDiagFlag is turned off in the PROFIBUS parameters, no PROFIBUS message is generated and OB82 is not activated. This is always recommended for applications which do not have to respond immediately to an error using OB82. In such cases the status can be processed using the message bit of the AS-i Flags or the Flags + Fault Detector bits for the normal PLC cycle. Error management can be structured on the basis of these messages.

	Operand	Symbol	Anzeigeforma	Statuswert	Steuerwert
1	EB 0	"IN_Flags_Slave1"	BIN	2#0001_0000	
2	EB 1	"IN_Slave2_Slave3"	BIN	2#0000_0000	
3	EB 2	"IN_Slave4_Slave5"	BIN	2#0000_0000	
4	EB 3	"IN_Slave6_Slave7"	BIN	2#0000_0000	
5	EB 4	"IN_Slave8_Slave9"	BIN	2#0000_0000	
6	E 0.4	"IN_ASI_Config_Error"	BOOL	true	
7	E 0.5	"IN_ASI_Power_Fail"	BOOL	false	
8	E 0.6	"IN_Periphery_Fault"	BOOL	false	
9	E 0.7	"IN_Configuration_Active"	BOOL	false	
10					
11	AB 0	"OUT_Flags_Slave1"	BIN	2#0000_0000	
12	AB 1	"OUT_Slave2_Slave3"	BIN	2#0000_0000	
13	AB 2	"OUT_Slave4_Slave5"	BIN	2#0000_0000	
14	AB 3	"OUT_Slave6_Slave7"	BIN	2#0000_0000	
15	AB 4	"OUT_Slave8_Slave9"	BIN	2#0000_0000	
16	A 0.4	"OUT_ASI_Off_Line"	BOOL	false	
17	A 0.5	"OUT_LOS_Masterbat"	BOOL	false	
18	A 0.6	"OUT_Configuration_Mode"	BOOL	false	false
19	A 0.7	"OUT_Protected_Mode"	BOOL	false	false
20					

In the diagnostic buffer of the CPU the configuration error which occurred is entered with "Module error".

The affected AS-i/DP Gateway can be ascertained from the diagnostic address of the slave which reports the error. This diagnostic address is evident as a parameter of the OB82 when it is invoked. The event is declared as an incoming event.

The diagnostic address, here 1022, refers to the specification in the hardware specification of the S7 with respect to the AS-i/DP Gateway.

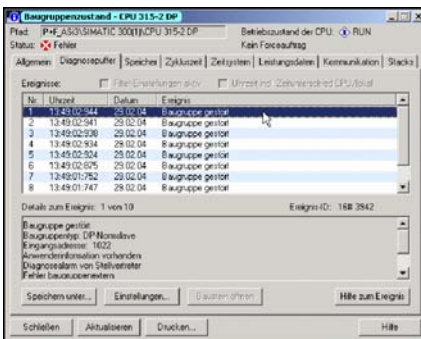

AS-i/PROFIBUS-Gateway

Appendix: Example for startup on a Siemens S7

As soon as the AS-i configuration error is cleared, the OB82 is invoked again. In turn the diagnostic address of the AS-i/DP Gateway, here 1022, is entered as a parameter and the event is declared as an outgoing event.

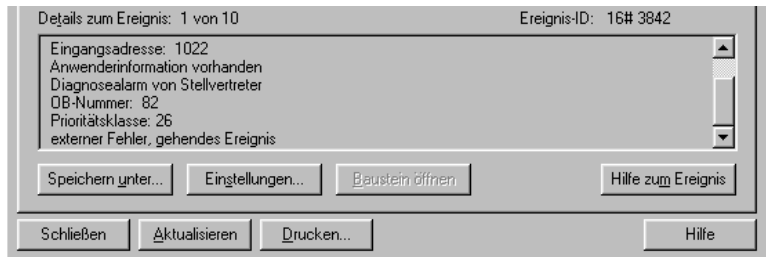
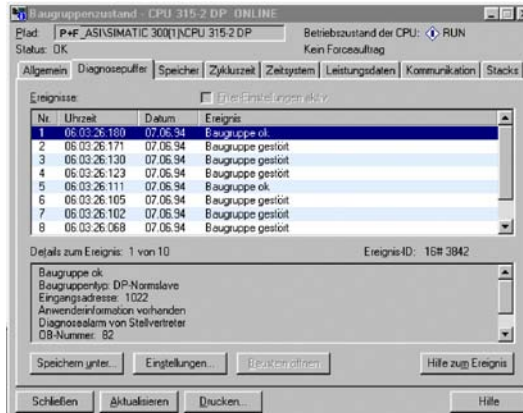

Entry of the error messages in the diagnostic buffer of the CPU and invoking of the OB82 is a consequence of the set ExtDiag flag for an error in the AS-i/DP Gateway.

This can be prevented by turning off the ExtDiag flag in the PROFIBUS parameters of the AS-i Gateway.

The errors can be responded to by the controller by querying the AS-i flag in the input data. This means a configuration error is reported twice in a standard case: Once via the AS-i flag Config Error and once via the ExtDiag flag in the PROFIBUS telegram.

If for timing reasons an AS-i error must be responded to in a non-interrupt controlled way, the message can be turned off using the ExtDiag flag. In this case it is sufficient to check the AS-i flag Config Error in the program sequence.

The same applies to the other messages.

If the message for various error states of the AS-i Gateway is activated via the PROFIBUS and if the data for the PROFIBUS diagnostic data are enabled, the SIEMENS function module SFC13 can be used to retrieve the PROFIBUS diagnostic

data of the AS-i Gateway and save them to a data module. Use of SFC13 is described in detail in the SIEMENS documentation for PROFIBUS.

13 Appendix: Codes indicated by the Display

In the basic state of the configuration mode, the display shows the addresses of all detected slaves at a rate of two per second one after the other. A blank display indicates that the *LDS* is empty, no slaves were detected.

In the basic state of the protected operating mode, the display is either blank or displays the address of a faulty assignment (see chapter 6.1.1).

During manual address programming, the slave address display has a different meaning (see chapter 6.2.7).

All displayed numbers bigger than 31 which can not be interpreted as a slave address are status or error messages of the master. They have the following meanings:

39	Advanced AS-i diagnostics: After pressing the 'set'-button a short-time AS-i power failure occurred.
40	The AS-i master is in offline phase.
41	The AS-i master is in detection phase.
42	The AS-i master is in activation phase.
43	The AS-i master starts the normal operating mode.
70	Hardware error: The AS-i master's EEPROM cannot be written.
71	Wrong PIC-type.
72	Hardware error: wrong PIC-processor.
73	Hardware error: wrong PIC-processor.
74	Checksum error in the EEPROM.
75	Error in the internal RAM.
76	Error in the external RAM.
77	AS-i control software error: Stack overflow (AS-i control II)
78	AS-i control software error: Checksum error in the control program.
80	Error while attempting to exit the configuration mode: A slave with address zero exists.
81	General error while changing a slave address.

AS-Interface

Appendix: Codes indicated by the Display

82	The front panel operation is blocked. Until repowering-up the device can only be accessed from the host via the interface.
83	Program reset of the AS-i Control programm: The AS-i Control programm is being read out of EEPROM and copied into the RAM.
88	Display test while starting up the AS-i master
90	Error while changing a slave address in protected operating mode: No slave with address 0 existing.
91	Error while changing slave address: Target address is already used.
92	Error while changing slave address: New address could not be set.
93	Error while changing slave address: New address could only be stored volatily in the slave.
94	Error while changing the slave address in protected operating mode: Slave has wrong configuration data.
95	The error 95 is caused by a superfluous slave and not by a missing slave. That is why the slave address is occupied by this superfluous slave. (In the protected mode the slave addresses which caused any configuration error can be displayed by pressing the SET button. AS-i master without graphical display are not able to differentiate between a missing slave, an incorrect slave or a redundant slave. All incorrect addresses are displayed. By pressing the SET button 5 sec. the displayed address starts to flash. Pressing the SET button again the master attempts to program the slave at the address 0 to the incorrect address.)

Issue date - 24.8.2007

14 Appendix: Installation Instructions

14.1 Listing of all described gateways

 Note	Please view the chapter 3, “Allgemeines,” on page 9 for the list of all devices described in this installation instruction.
---	---

14.2 VBG-PB-K20-D

AS-i 3.0 PROFIBUS-Gateway in Edelstahl
AS-i 3.0 PROFIBUS Gateway in Stainless Steel
Passerelle AS-i 3.0 PROFIBUS DP en boîtier inox
Gateway AS-i 3.0 PROFIBUS d'acciaio inox
Pasarela AS-i 3.0 PROFIBUS en acero inoxidable



Dokumentation AS-i/PROFIBUS-Gateways (deutsch)
 Documentation AS-i/PROFIBUS-Gateways (english)



Attention

Die Geräte dürfen nur von Fachpersonal aufgebaut, angeschlossen und in Betrieb genommen werden! / Only qualified staff is allowed to mount, connect and set up the modules! / Les modules ne doivent être montés, raccordés et mis en service que par du personnel qualifié! / Gli apparecchi possono essere montati, collegati e messi in funzione soltanto da personale specializzato! / Los aparatos sólo pueden ser montados, conectados y puestos en servicio por personal técnico especializado!

14.2.1 Dimensions

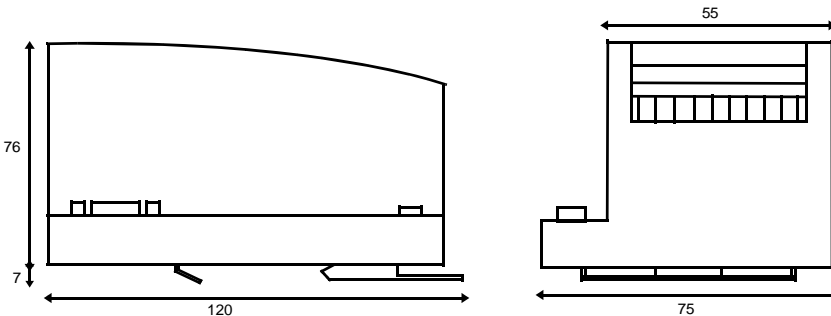

Issue date - 24.8.2007

14.2.2 Front view and connections

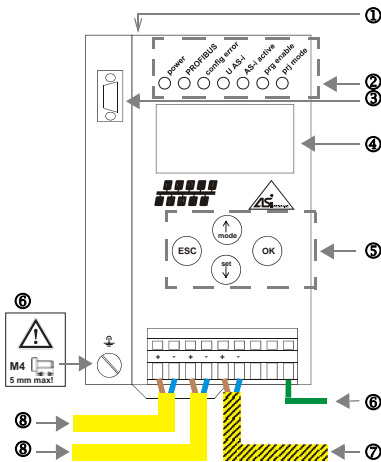

- ⑦ AS-i-Netzteil/ AS-i power supply/ Alimentation AS-i/ Alimentatore AS-i/ Alimentación AS-i
- ⑧ AS-i-Kreis /AS-i circuit /Bus AS-i / Circuito AS-i / Circuito AS-i

- ① RS 232 Anschluss
- ② LED-Statusanzeige
- ③ PROFIBUS-Anschluss
- ④ LCD-Anzeige
- ⑤ Tasten für Handbedienung
- ⑥ Erde

- ① RS 232 connection
- ② LED status display
- ③ PROFIBUS connection
- ④ LCD display
- ⑤ Buttons for hand operation
- ⑥ Ground

- ① Raccordement RS 232
- ② Affichage d'état DEL
- ③ Raccordement PROFIBUS
- ④ Affichage LCD
- ⑤ Boutons pour commande manuelle
- ⑥ Terre

Hinweis/Hint/Remarque/Nota/Nota

Am Kabel für das Netzteil dürfen keine Slaves oder Repeater angeschlossen werden.

Am Kabel für den AS-i-Anschluss dürfen keine AS-i-Netzteile oder weitere Master angeschlossen werden.

At the cable for power supply no slaves or repeaters may be attached.

At the cable for AS-i circuit no power supplies or further masters may be attached.

Au câble pour l'alimentation aucun esclave ou répéteur ne peut être raccordé.

Au câble pour le circuit AS-i aucune alimentation ou autre maître ne peut être raccordé.

Al cavo per l'alimentazione nessun slave o ripetitore può essere fissato.

Al cavo per il circuito AS-i nessun alimentatore o altro master può essere fissato.

En el cable de la alimentación AS-i no se deben conectar esclavos o repetidores.

En el cable del circuito AS-i no se debe conectar ninguna fuente de poder AS-i u otro master.

Operating temperature: 0°C ... +55°C

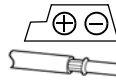

Temperature rating for cable: 60/75°C

Use copper conductors only

1 x 0.5 - 1.5 mm² (16AWG/kcmil: min. 24/max.12)

- ① Collegamento RS 232
- ② Visualizzazione di stato LED
- ③ Collegamento PROFIBUS
- ④ Visualizzazione LCD
- ⑤ Pulsanti per le impostazioni manuali
- ⑥ Terra

- ① Conexión RS 232
- ② LED visualización
- ③ Conexión PROFIBUS
- ④ Display LCD
- ⑤ Teclas para accionamiento manual
- ⑥ Tierra

14.2.3 Startup

14.2.3.1 Switching to advanced display mode

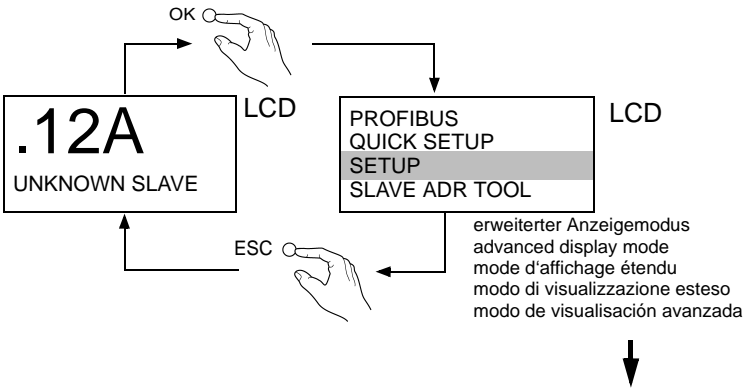

klassische Anzeige
classical display
affichage classique
display classico
indicación clásica



Aufbau siehe Zusatzblatt
structure see additional page
structure voir page supplémentaire
struttura vedi pagina supplementare
estructura ver página adicional

14.2.4 Setting the PROFIBUS-DP address

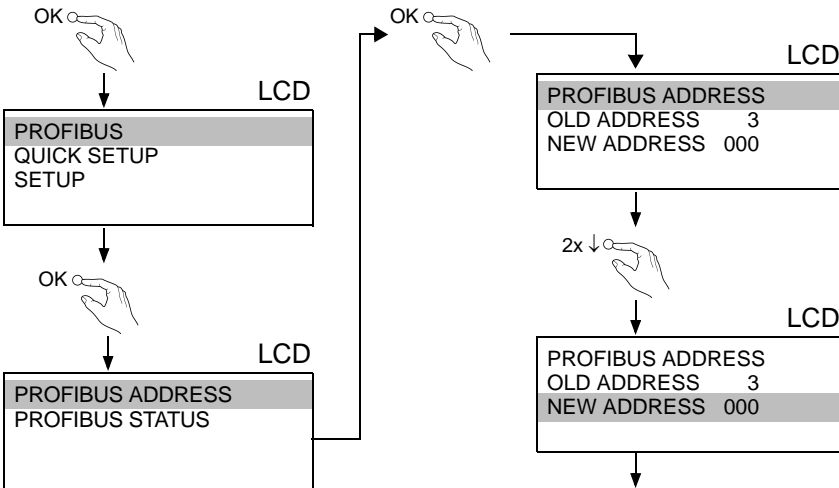

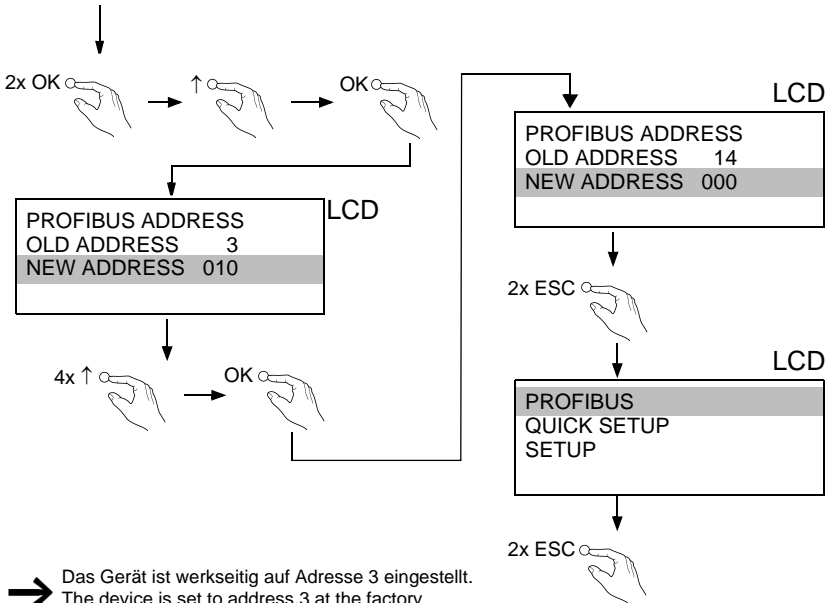

➔ Das Gerät ist werkseitig auf Adresse 3 eingestellt.
 The device is set to address 3 at the factory.
 L'appareil est réglé en usine à l'adresse 3.
 L'apparecchio è messo all'indirizzo 3 dalla fabbrica.
 El aparato viene ajustado de fábrica con la dirección 3.

14.2.5 Connecting AS-i Slaves

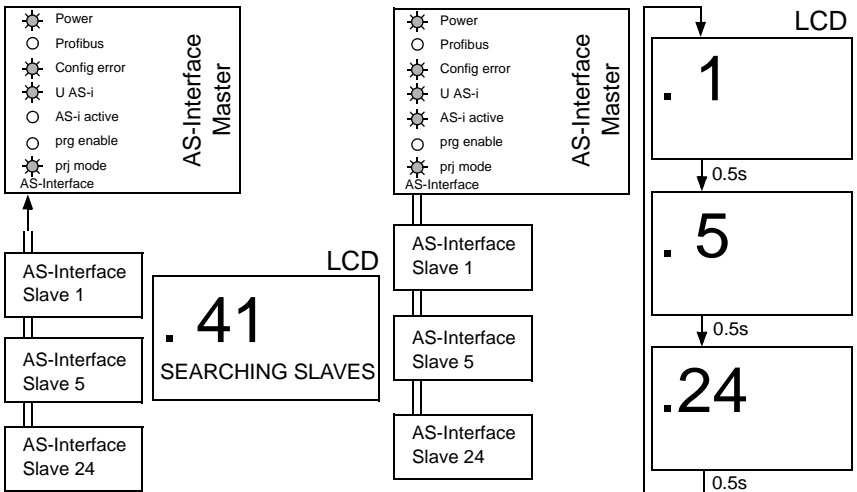

Issue date - 24.8.2007

14.2.6 Quick setup

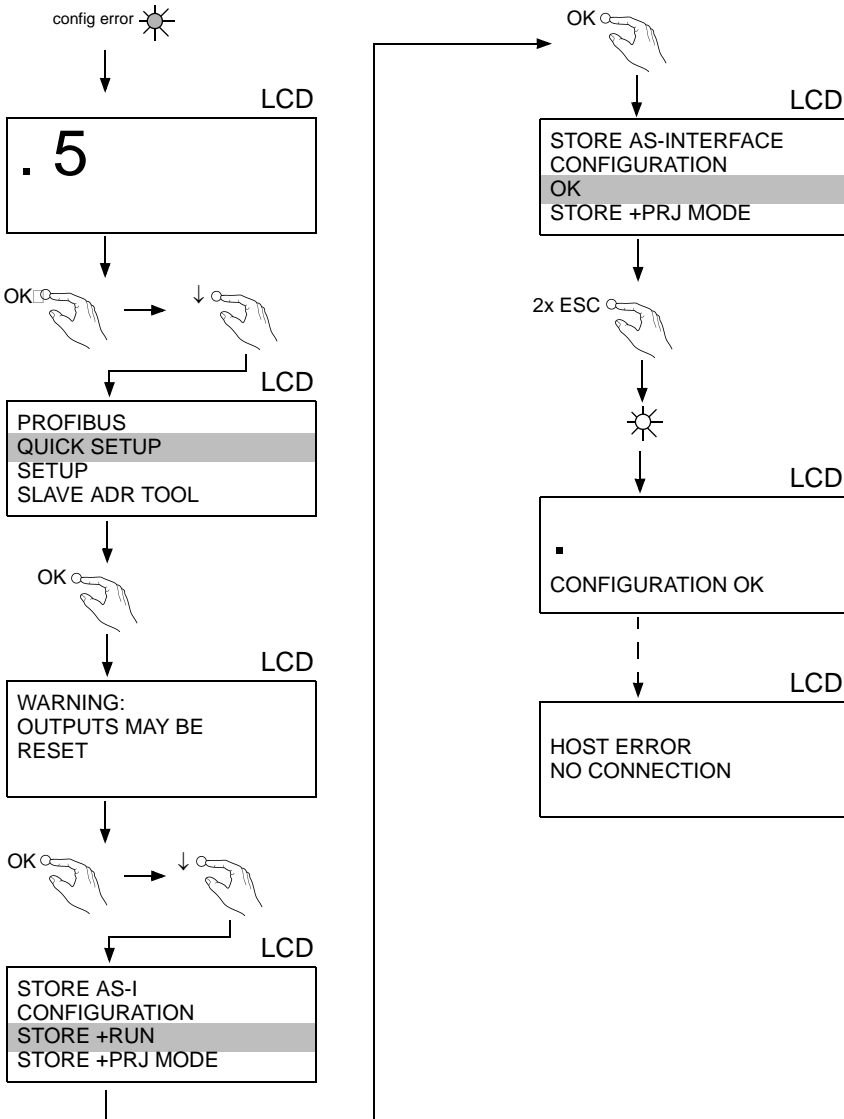

Issue date - 24.8.2007

14.2.7 Error tracing

14.2.7.2 Faulty slaves



14.2.7.3 Error display (last error)

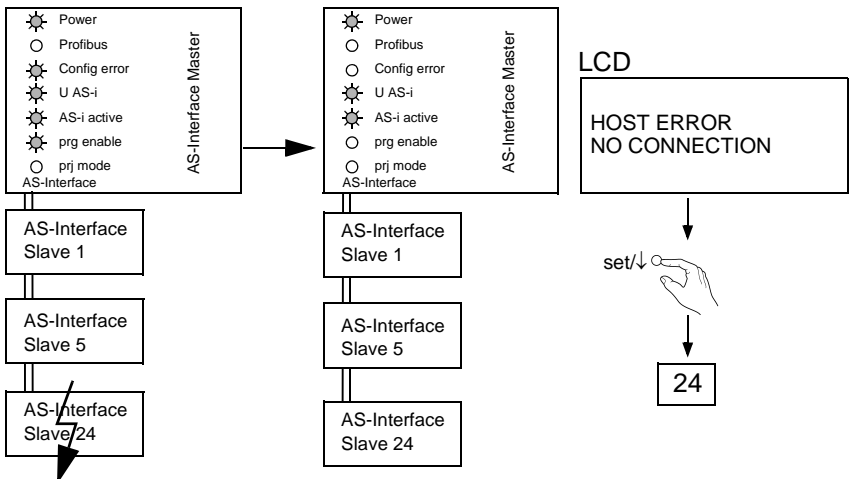

14.2.8 Addressing

14.2.8.4 Program slave 0 to address 4

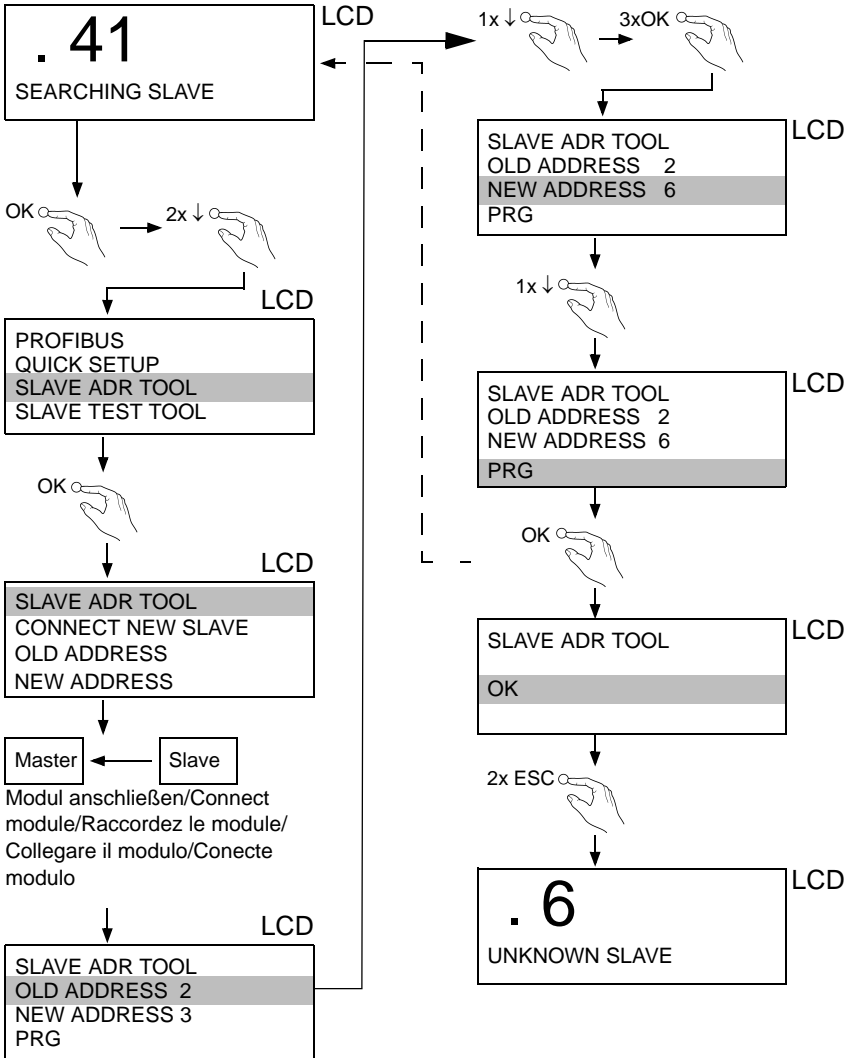

Issue date - 24.8.2007

14.2.9 Montage

auf Montageplatte mit 35-mm-Hutschiene ①
on mounting plate with 35 mm top-hat rail ①
sur plaque de montage avec profilé-support 35 mm ①
su piastra di montaggio con guida DIN 35 mm ①
sobre placa de montaje con guía simétrica de 35 mm ①

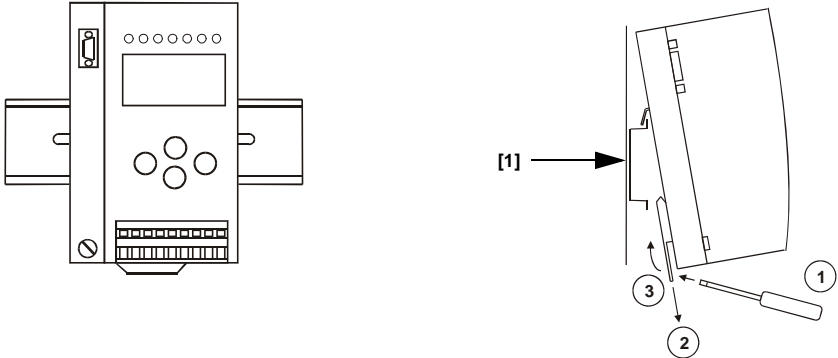

14.2.10 Accessories

- AS-i-Netzteil 4 A / AS-i Power supply 4 A / Alimentation 4 A AS-i / Alimentazione 4 A AS-i / Fuente de poder AS-i 4 A
- PC-Software „AS-i Control Tools“ mit seriellm Kabel zum Anschluss des AS-i Master in Edelstahl / Software "AS-i Control Tools" with serial cable for connection of the AS-i Master in stainless steel / Logiciel "AS-i Control Tools" avec câble série pour la connexion du maître AS-i en acier inox / Software PC "AS-i Control Tools" con cavo seriale per il collegamento del master AS-i di acciaio inox / Software de PC "AS-i Control Tools" con cable serial para la conexión del AS-i Master en acero inoxidable
- Serieller PROFIBUS-Master / Serial PROFIBUS Master / Maître PROFIBUS série / Master seriale PROFIBUS / Master PROFIBUS serial

14.3 VBG-PB-K20-DMD

AS-i 3.0 PROFIBUS-Gateway in Edelstahl
AS-i 3.0 PROFIBUS Gateway in Stainless Steel
Passerelle AS-i 3.0 PROFIBUS DP en boîtier inox
Gateway AS-i 3.0 PROFIBUS d'acciaio inox
Pasarela AS-i 3.0 PROFIBUS en acero inoxidable



Documentation AS-i/PROFIBUS-Gateways (english)



Attention

Die Geräte dürfen nur von Fachpersonal aufgebaut, angeschlossen und in Betrieb genommen werden! / Only qualified staff is allowed to mount, connect and set up the modules! / Les modules ne doivent être montés, raccordés et mis en service que par du personnel qualifié! / Gli apparecchi possono essere montati, collegati e messi in funzione soltanto da personale specializzato! / Los aparatos sólo pueden ser montados, conectados y puestos en servicio por personal técnico especializado!

14.3.1 Dimensions

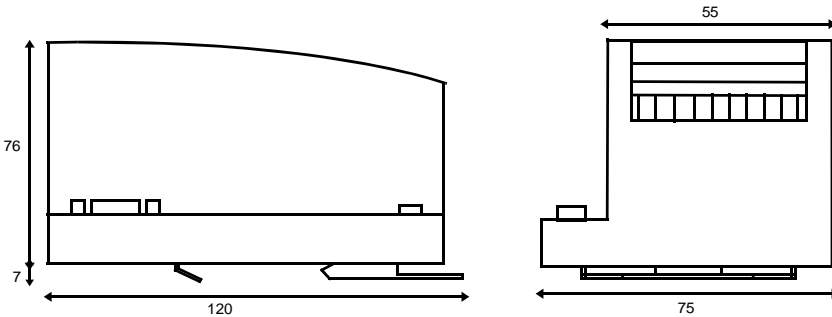

Issue date - 24.8.2007

14.3.2 Front view and connections

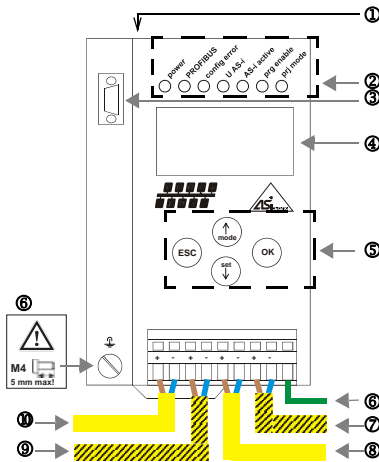

- ⑦ AS-i-Netzteil Kreis 2 / AS-i Power supply circuit 2 / Alimentation bus 2 AS-i / Alimentazione circuito 2 AS-i / Alimentación circuito 2 AS-i/Circuito AS-i 2
- ⑧ AS-i-Kreis 2/AS-i circuit 2/Bus AS-i 2/ Circuito AS-i 2 / Circuito AS-i 2
- ⑨ AS-i-Netzteil Kreis 1/AS-i Power supply circuit 1/ Alimentation bus 1 AS-i / Alimentazione circuito 1 AS-i / Alimentación circuito 1 AS-i/Circuito AS-i 1
- ⑩ AS-i-Kreis 1/AS-i circuit 1/Bus AS-i 1/ Circuito AS-i 1 / Circuito AS-i 1

- ① RS 232 Anschluss
 - ② LED-Statusanzeige
 - ③ PROFIBUS-Anschluss
 - ④ LCD-Anzeige
 - ⑤ Tasten für Handbedienung
 - ⑥ Erde
-
- ① Raccordement RS 232
 - ② Affichage d'état DEL
 - ③ Raccordement PROFIBUS
 - ④ Affichage LCD
 - ⑤ Boutons pour commande manuelle
 - ⑥ Terre

Hinweis/Hint/Remarque/Indicazione/Nota

AS-i-Kreis 1 und 2 werden aus AS-i-Netzteilen versorgt. Am Kabel für das Netzteil dürfen keine Slaves oder Repeater angeschlossen werden.

Am Kabel für den AS-i-Anschluss dürfen keine AS-i-Netzteile oder weitere Master angeschlossen werden.

AS i circuit 1 and 2 are supplied from AS-i power supplies. At the cable for power supply no slaves or repeaters may be attached.

At the cable for AS-i circuit no power supplies or further masters may be attached.

Les bus AS-i 1 et 2 sont alimentés par AS-i.

Au câble pour l'alimentation aucun esclave ou répéteur ne peut être raccordé.

Au câble pour le circuit AS-i aucune alimentation ou autre maître ne peut être raccordé.

I circuiti AS-i 1 e 2 sono alimentati da AS-i.

Al cavo per l'alimentazione nessun slave o ripetitore può essere fissato.

Al cavo per il circuito AS-i nessuna alimentazione o altro master può essere fissato.

Los circuitos AS-i 1 y 2 son alimentados de la fuente de poder AS-i.

En el cable de la alimentación AS-i no se deben conectar esclavos o repetidores.

En el cable del circuito AS-i no se debe conectar ninguna fuente de poder AS-i u otro master.

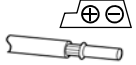

Temperature rating for cable: 60/75°C
Use copper conductors only

Ambient operating temperature: 0°C ... +55°C
1 x 0.5 - 1.5 mm² (16AWG/kcmil: min. 24/max. 12)

- ① Collegamento RS 232
 - ② Visualizzazione di stato LED
 - ③ Collegamento PROFIBUS
 - ④ Visualizzazione LCD
 - ⑤ Pulsanti per le impostazioni manuali
 - ⑥ Terra
-
- ① Conexión RS 232
 - ② LED visualización
 - ③ Conexión PROFIBUS
 - ④ Display LCD
 - ⑤ Teclas para accionamiento manual
 - ⑥ Tierra

14.3.3 Startup

14.3.3.5 Switching to advanced display mode

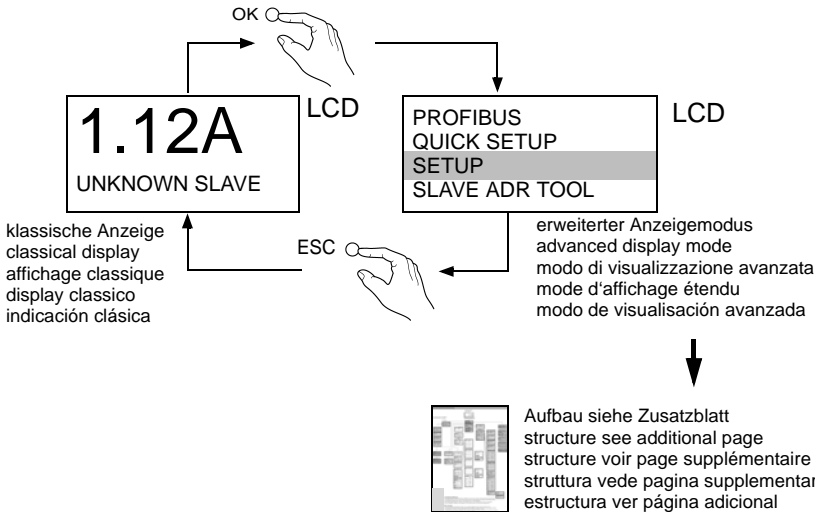

14.3.4 Setting the PROFIBUS-DP address

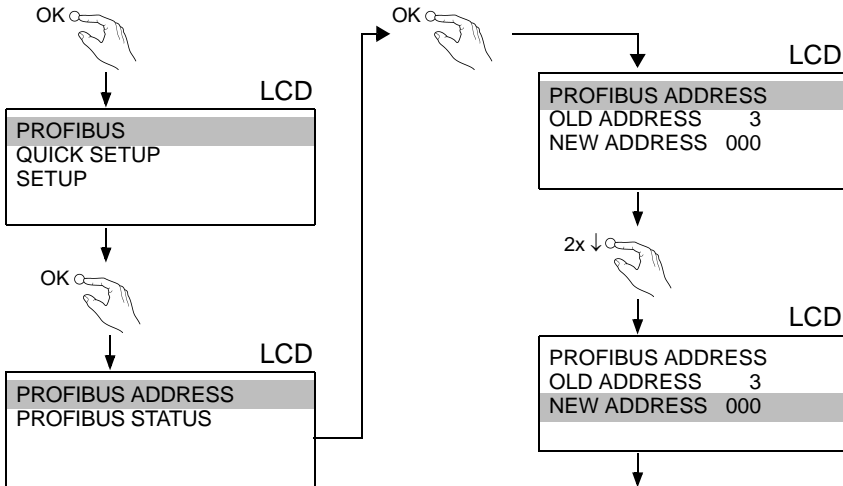

Issue date - 24.8.2007

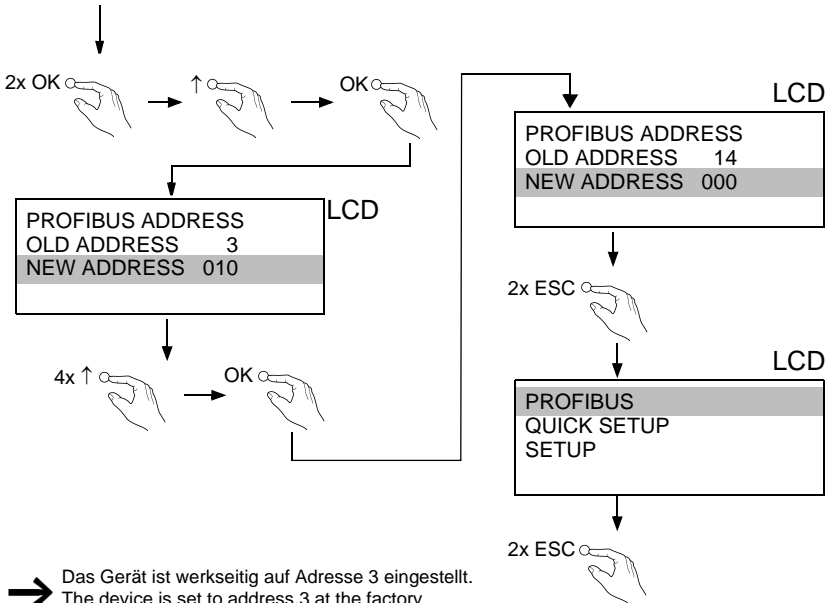

➔ Das Gerät ist werkseitig auf Adresse 3 eingestellt.
 The device is set to address 3 at the factory.
 L'appareil est réglé en usine à l'adresse 3.
 L'apparecchio è messo all'indirizzo 3 dalla fabbrica.
 El aparato viene ajustado de fábrica con la dirección 3.

14.3.5 Connecting AS-i Slaves

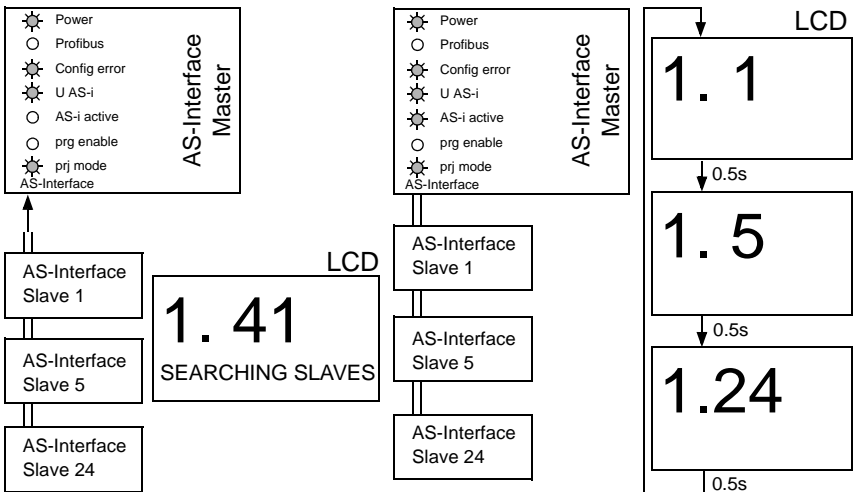

Issue date - 24.8.2007

14.3.6 Quick setup

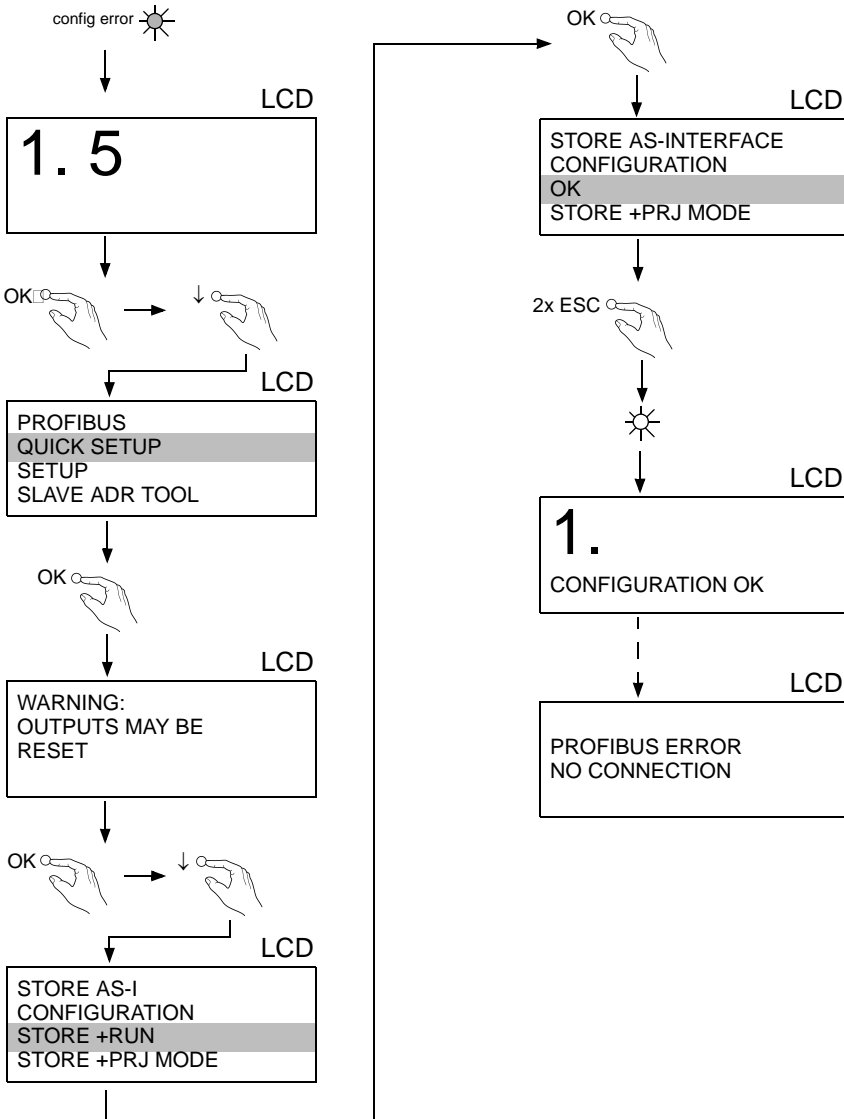

Issue date - 24.8.2007

14.3.7 Error tracing

14.3.7.6 Faulty slaves



14.3.7.7 Error display (last error)

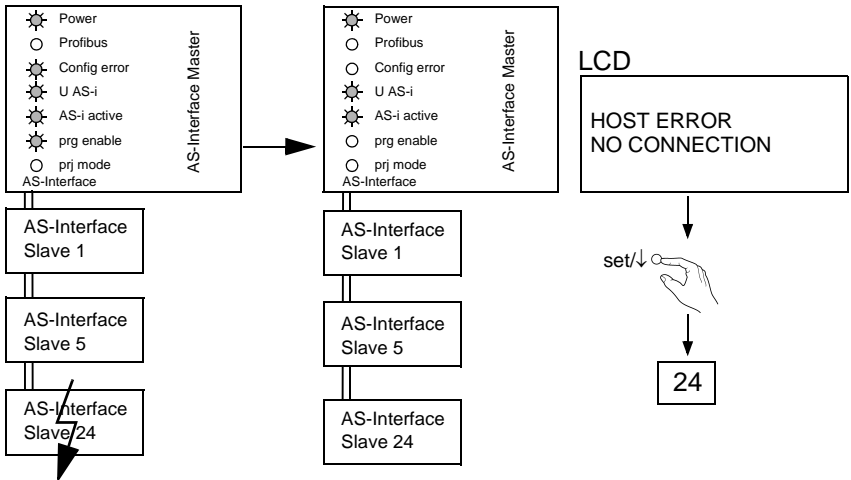

14.3.8 Addressing

14.3.8.8 Programming slave 2 to address 6

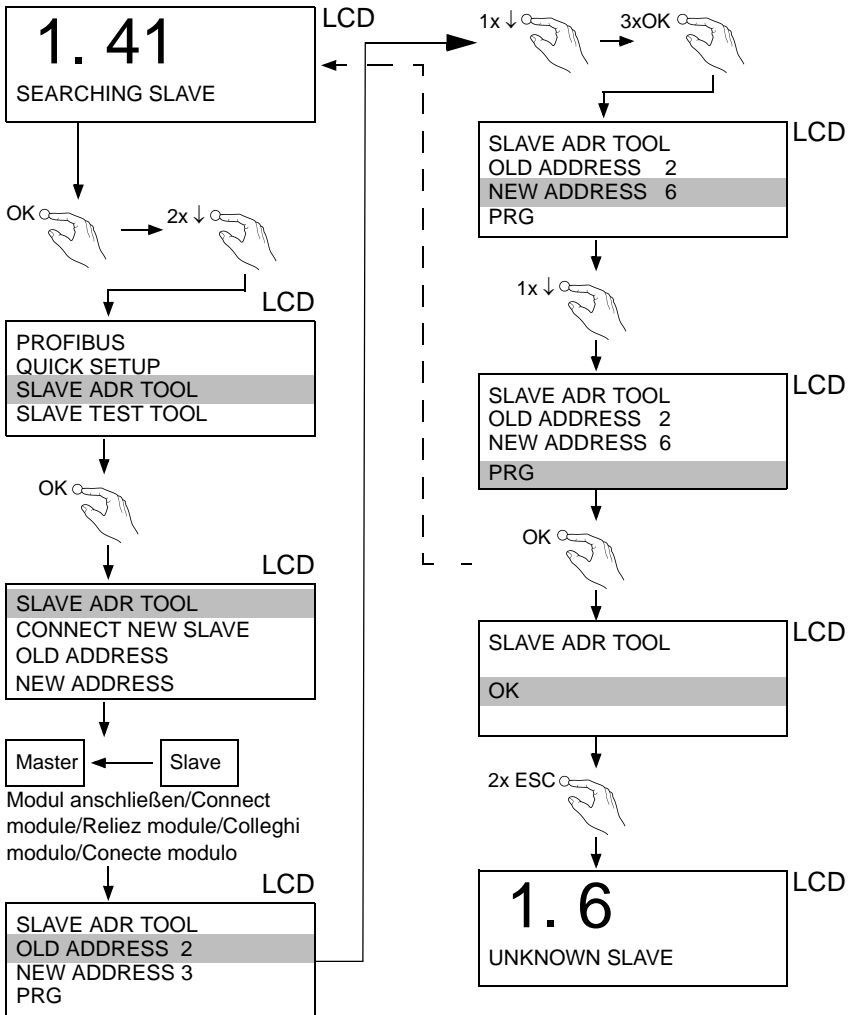

Issue date - 24.8.2007

14.3.9 Montage

auf Montageplatte mit 35-mm-Hutschiene ①
on mounting plate with 35 mm top-hat rail ①
sur plaque de montage avec profilé-support 35 mm ①
su piastra di montaggio con guida DIN 35 mm ①
sobre placa de montaje con guía simétrica de 35 mm ①

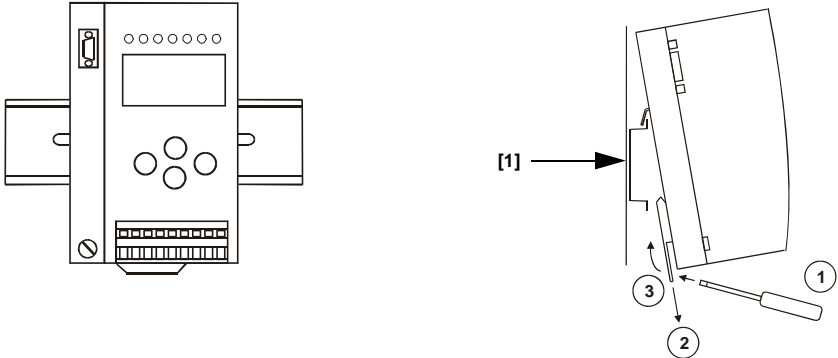

14.3.10 Accessories

- AS-i-Netzteil 4 A / AS-i Power supply 4 A / Alimentation 4 A AS-i / Alimentazione 4 A AS-i / Fuente de poder AS-i 4 A
- PC-Software „AS-i Control Tools“ mit seriellem Kabel zum Anschluss des AS-i Master in Edelstahl / Software "AS-i Control Tools" with serial cable for connection of the AS-i Master in stainless steel / Logiciel "AS-i Control Tools" avec câble série pour la connexion du maître AS-i en acier inox / Software PC "AS-i Control Tools" con cavo seriale per il collegamento del master AS-i di acciaio inox / Software de PC "AS-i Control Tools" con cable serial para la conexión del AS-i Master en acero inoxidable
- Serieller PROFIBUS-Master / Serial PROFIBUS Master / Maître PROFIBUS série / Master seriale PROFIBUS / Master PROFIBUS serial

15 Glossary: AS-i Terms

A/B slave

AS-i slave with extensible addressing: The address range of an A/B slave runs from 1A to 31A and from 1B to 31B. As the master needs the fourth output data bit for switching between A and B address, A/B slaves only have three output data bits maximum.

Activation phase

In the activation phase the detected slaves are activated by sending the parameter. This is indicated by a "42" on the Master's Display. This phase takes only 10 ms, tops, to short to be displayed.

AS-i power fail

Voltage drop on the AS-i line; by falling below an assigned value the master changes to the ⇒ *Off-line phase*.

Inclusion phase

After the data exchange with all AS-i slaves the master is searching for new slaves. For this purpose an detection telegram is sent to one AS-i address and in case of an answer the master tries to read the ⇒ *actual configuration* of the slave. Depending on the mode (⇒ *protected mode* or ⇒ *configuration mode*) and on the actual configuration the detected slave will be activated.

After each data exchange with all AS-i slaves only one detection telegram is sent to one slave address. So the AS-i cycle is always one telegram longer as expected from the number of activated slaves (⇒ LAS).

Autoprogram flags

Auto Address Enable; flag from the Host to the AS-i Master

With this flag, automatic addressing can be enabled or inhibited.

This flag is stored non-volatile in the Master.

Auto Address Assign, Auto Address Possible; flag from the AS-i Master to the Host

The automatic programming is not inhibited and there is no configuration error.

A failing slave could be addressed automatically.

Auto Address Available, flag from the AS-i Master to the Host

Exactly one AS-i slave is missing and the automatic programming is not inhibited.

If a slave with the address 0 and the profile of the missing slave is connected, it receives the address of the missing slave automatically.

IO-Code

The first digit of the slave profile indicates the number of inputs and outputs of the slave. A 4I/4O slave e.g. is associated to "7", a slave with 4 digital Inputs to "0".

Detection phase

In the detection phase at start-up the master is scanning for AS-i slaves. It remains in this phase until at least one slave is detected. If the master remains in the detection phase this means that no slave was found. The reason for this may be a wrong power supply or a wiring error.

The detection phase is displayed by code "41".

Protected mode

In protected mode only those slaves are activated which are registered in the ⇒ *LPS* and whose actual configuration matches with the target configuration.

See ⇒ *configuration mode*. This mode is intended for the normal operation, since all AS-i protective measures are activated.

ID code

The ID code is unchangeably set by the manufacturer of the AS-i slave. The AS-i Association defines the ID codes assigned to a certain category of slaves. All ⇒ *A/B slaves* e.g. possess the ID code "A".

ID1 code, extended ID1 code

The ID1 code is specified by the manufacturer of the slave. In contrast to the other codes defining the profile this code can be modified by the master or by an addressing unit. The user should make use of this possibility only in exceptional cases, otherwise ⇒ *configuration errors* may occur.

To make the distinction between the A and the B addresses in the case of A/B slaves, the bit with the highest value of the ID1 code is used. That is why only the three lowest bits are relevant for these slaves. Since this code has been introduced with the new AS-i specification 2.1, it is also called extended ID1 code.

ID2 code, extended ID2 code

The ID2 code is unchangeably set by the manufacturer of the slave. The AS-i Association defines the ID2 codes assigned to a certain category of slaves. All two-channel 16-bit input slaves with the profile S-7.3 possess the ID2 code "D". Since this code has been introduced with the new AS-i specification 2.1, it is also called extended ID2 code.

Actual configuration

The configuration data of all slaves detected by the master. The configuration data of one slave, the ⇒ *slave profile*, consists of:

⇒ *IO code*, ⇒ *ID code*, ⇒ *extended ID1code 1*, ⇒ *extended ID2 code*.

Actual parameter

The AS-i parameter that have been sent last to the AS-i slave, in contrary to ⇒ *permanent parameters*.

Configuration Error/Config Error

An configuration error is indicated, when target and actual configuration of the connected slaves do not match. The following cases may result in configuration errors:

Missing slave:A slave entered in the \Rightarrow *LPS* is not available

Erroneous type of slave:The \Rightarrow *slave profile* of the connected slave does not comply with the configured one.

Unknown slave:A connected slave is not entered in the \Rightarrow *LPS*.

LAS - List of Activated Slaves

The master exchanges IO data with the slaves entered in the LAS. In the protected mode only those detected slaves (\Rightarrow *LDS*) are activated which are expected by the master and are entered in the \Rightarrow *LPS*. In the configuration mode all slaves entered in the \Rightarrow *LDS* are activated.

LDS - List of Detected Slaves

All slaves from which the master was able to read the \Rightarrow *slave profile* are entered in the LDS.

LPF - List of Peripheral Faults

There is a list of peripheral faults only for masters fulfilling the new specification 2.1. This list includes an entry for each slave that signals a \Rightarrow *peripheral fault*.

LPS - List of Projected Slaves

The list of projected slaves includes all slaves expected by the master. All entries of the \Rightarrow *LDS* are taken over to the LPS by storing the actual configuration (except for a not addressed slave with the address 0).

Offline phase

In the offline phase all input and output data is reset. This phase is entered at start-up of the master, after a \Rightarrow *AS-i power fail*, and at the transition of the \Rightarrow *configuration mode* to the \Rightarrow *protected mode*.

Furthermore the master can actively be put into the offline phase with the offline flag.

During the offline phase, masters with a display show code "40".

Peripheral fault

A peripheral fault is shown on the master and on the slave by a red flashing LED. Depending on the slave type it is possible to visualize an overflow, an overload of the sensor's power supply or another fault regarding the peripheral equipment of the slave.

Permanent configuration

The configuration data of all expected slaves stored in the master (\Rightarrow *slave profile*). If the permanent configuration differs from the \Rightarrow *actual configuration*, there is a configuration error.

Permanent parameter

The parameter stored in the master that are sent to the slave after start-up of the master in the \Rightarrow *activation phase*.

Configuration mode

During the configuration mode the master exchanges data with all connected slaves, no matter which of the slaves are projected. In this mode it is possible to commission a system without being obliged to configure it before.

See also \Rightarrow *protected mode*.

Single slave

Compared to an \Rightarrow *A/B slave* a single slave can only be addressed from the address 1 to 31; the fourth data output bit can be used. All slaves of the older specification 2.0 are single slaves.

There are also slaves fulfilling the new specification 2.1 that are single slaves, e.g. the newer 16-bit slaves.

Slave profile

The configuration data of a slave consisting of:

\Rightarrow *IO code*, \Rightarrow *ID code*, \Rightarrow *extended ID1 code*, \Rightarrow *extended ID2 code*.

The slave profile is to differentiate between the different slave categories. It is specified by the AS-i Association and preset by the slave manufacturer.

AS-i 2.0 slaves do not have extended ID1 and ID2 codes. In this case an AS-i master 2.1 enters "F" the extended ID1 and the extended ID2 code.

FACTORY AUTOMATION – SENSING YOUR NEEDS



Worldwide Headquarters

Pepperl+Fuchs GmbH
68307 Mannheim · Germany
Tel. +49 621 776-0
E-mail: info@de.pepperl-fuchs.com

USA Headquarters

Pepperl+Fuchs Inc.
Twinsburg, Ohio 44087 · USA
Tel. +1 330 4253555
E-mail: sales@us.pepperl-fuchs.com

Asia Pacific Headquarters

Pepperl+Fuchs Pte Ltd.
Company Registration No. 199003130E
Singapore 139942
Tel. +65 67799091
E-mail: sales@sg.pepperl-fuchs.com

www.pepperl-fuchs.com

 **PEPPERL+FUCHS**
SENSING YOUR NEEDS

Subject to modifications
Copyright PEPPERL+FUCHS • Printed in Germany

TDOCT-0595BENG

133562
09/2007