



Overload relay, ZB32, I_r= 10 - 16 A, 1 N/O, 1 N/C, Direct mounting, IP20



Referencia ZB32-16
Catalog No. 278452
Alternate Catalog No. XTOB016CC1

Delivery program

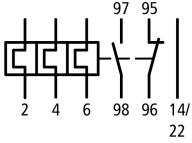

Product range			Overload relay ZB up to 150 A
Product range			Accessories
Accessories			Overload relays
Frame size			ZB32
Phase-failure sensitivity			IEC/EN 60947, VDE 0660 Part 102
Description			Test/off button Reset pushbutton manual/auto Trip-free release
Mounting type			Direct mounting
	I _r	A	10 - 16
Contact sequence			

Auxiliary contacts

N/O = Normally open			1 N/O
N/C = Normally closed			1 N/C

For use with			DILM17, DILM25, DILM32, DILM38, DILMF8, DILMF11, DILMF14, DILMF17, DILMF25, DILMF32, DIULM17, DIULM25, DIULM32, SDAINLM30, SDAINLM45, SDAINLM55, DS7-34...SX016...
--------------	--	--	--

Short-circuit protection

Type "1" coordination 	gG/gL	A	63
Type "2" coordination 	gG/gL	A	35

Notes

Overload release: tripping class 10 A
 short-circuit protective device: Observe the maximum permissible fuse of the contactor with direct device mounting.
 Suitable for protection of Ex e-motors.



II(2)G [Ex d] [Ex e] [Ex px], II(2)D [Ex p] [Ex t]

PTB 10 ATEX 3010

Notes

Fitted directly to the contactor

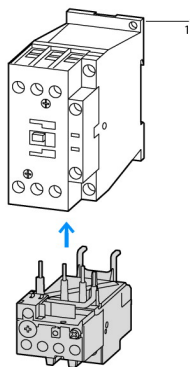

Separate mounting

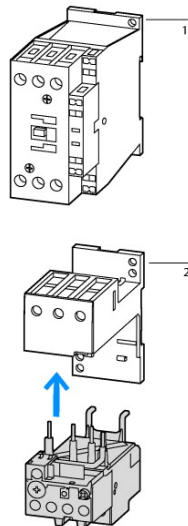

1 Contactor
2 Bases

Technical data

General

Standards			IEC/EN 60947, VDE 0660, UL, CSA
Climatic proofing			Damp heat, constant, to IEC 60068-2-78 Damp heat, cyclic, to IEC 60068-2-30
Ambient temperature			Operating range to IEC/EN 60947 PTB: -5 °C - +55 °C
Open	°C		-25 - +55
Enclosed	°C		-25 - 40
Temperature compensation			Continuous
Weight	kg		0.146
Mechanical shock resistance	g		10 Sinusoidal Shock duration 10 ms
Degree of Protection			IP20
Protection against direct contact when actuated from front (EN 50274)			Finger and back-of-hand proof
Altitude	m		Max. 2000

Main conducting paths

Rated impulse withstand voltage	U_{imp}	V AC	6000
Overvoltage category/pollution degree			III/3
Rated insulation voltage	U_i	V	690
Rated operational voltage	U_e	V AC	690
Safe isolation to EN 61140			
Between auxiliary contacts and main contacts		V AC	440
Between main circuits		V AC	440
Temperatur compensation residual error > 40 °C			≤ 0.25 %/K
Current heat loss (3 conductors)			
Lower value of the setting range		W	3
Maximum setting		W	5.4
Terminal capacities		mm ²	
Solid		mm ²	1 x (1 - 6) 2 x (1 - 6)
Flexible with ferrule		mm ²	1 x (1 - 4) 2 x (1 - 4)
Solid or stranded		AWG	18 - 8
Terminal screw			M4
Tightening torque		Nm	1.8
Stripping length		mm	10

Tools			
Pozidriv screwdriver		Size	2
Standard screwdriver		mm	1 x 6

Auxiliary and control circuits

Rated impulse withstand voltage	U_{imp}	V	4000
Overvoltage category/pollution degree			III/3
Terminal capacities		mm ²	
Solid		mm ²	1 x (0.75 - 4) 2 x (0.75 - 4)
Flexible with ferrule		mm ²	1 x (0.75 - 2.5) 2 x (0.75 - 2.5)
Solid or stranded		AWG	2 x (18 - 14)
Terminal screw			M3.5
Tightening torque		Nm	1.2
Stripping length		mm	8
Tools			
Pozidriv screwdriver		Size	2
Standard screwdriver		mm	1 x 6
Rated insulation voltage	U_i	V AC	500
Rated operational voltage	U_e	V AC	500
Safe isolation to EN 61140			
between the auxiliary contacts		V AC	240
Conventional thermal current	I_{th}	A	6
Rated operational current	I_e	A	
AC-15			
Make contact			
120 V	I_e	A	1.5
220 V 230 V 240 V	I_e	A	1.5
380 V 400 V 415 V	I_e	A	0.5
500 V	I_e	A	0.5
Break contact			
120 V	I_e	A	1.5
220 V 230 V 240 V	I_e	A	1.5
380 V 400 V 415 V	I_e	A	0.9
500 V	I_e	A	0.8
DC L/R ≤ 15 ms			
			Switch-on and switch-off conditions based on DC-13, time constant as specified.
24 V	I_e	A	0.9
60 V	I_e	A	0.75
110 V	I_e	A	0.4
220 V	I_e	A	0.2
Short-circuit rating without welding			
max. fuse		A gG/gL	6

Notes

Notes Ambient air temperature: Operating range to IEC/EN 60947, PTB: -5°C to +55°C
Main circuits terminal capacity solid and flexible conductors with ferrules: When using 2 conductors use equal cross-sections.

Rating data for approved types

Auxiliary contacts			
Pilot Duty			
AC operated			B300 at opposite polarity B600 at same polarity
DC operated			R300
Short Circuit Current Rating			
600 V High Fault		SCCR	
SCCR (fuse)		kA	100
max. Fuse		A	35 Class J

Design verification as per IEC/EN 61439

Datos técnicos para la verificación del diseño			
Intensidad asignada de empleo para disipación térmica específica	I_n	A	16
Disipación térmica por polo, en función de la intensidad	P_{vid}	W	1.8
Disipación térmica del equipo, en función de la intensidad	P_{vid}	W	5.4
Disipación térmica estática, en función de la intensidad	P_{vs}	W	0
Capacidad de disipación térmica	P_{diss}	W	0
Temperatura ambiente mínima de funcionamiento		°C	-25
Temperatura ambiente máxima de funcionamiento		°C	55
Verificación de diseño IEC / EN 61439			
10.2 Resistencia de materiales y piezas			
10.2.2 Resistencia a la corrosión			
			Cumple con los requisitos de la norma del producto.
10.2.3.1 Verificación de la estabilidad térmica de los armarios			
			Cumple con los requisitos de la norma del producto.
10.2.3.2 Verificación de la resistencia de los materiales aislantes en condiciones de calor normales			
			Cumple con los requisitos de la norma del producto.
10.2.3.3. Verificación de la resistencia de los materiales aislantes al calor excesivo y al fuego debido a los efectos eléctricos internos			
			Cumple con los requisitos de la norma del producto.
10.2.4 Resistencia a radiación ultravioleta (UV)			
			Cumple con los requisitos de la norma del producto.
10.2.5 Elevación			
			No se aplica, ya que todo el equipo de conmutación debe ser evaluado.
10.2.6 Impacto mecánico			
			No se aplica, ya que todo el equipo de conmutación debe ser evaluado.
10.2.7 Inscripciones			
			Cumple con los requisitos de la norma del producto.
10.3 Grado de protección de montajes			
			No se aplica, ya que todo el equipo de conmutación debe ser evaluado.
10.4 Distancias de separación y fuga			
			Cumple con los requisitos de la norma del producto.
10.5 Protección contra descargas eléctricas			
			No se aplica, ya que todo el equipo de conmutación debe ser evaluado.
10.6 Incorporación de dispositivos y componentes de conmutación			
			No se aplica, ya que todo el equipo de conmutación debe ser evaluado.
10.7 Conexiones y circuitos eléctricos internos			
			Es responsabilidad del cuadrista.
10.8 Conexiones de conductores externos			
			Es responsabilidad del cuadrista.
10.9 Propiedades de aislamiento			
10.9.2 Resistencia eléctrica de frecuencia de alimentación			
			Es responsabilidad del cuadrista.
10.9.3 Tensión de impulso soportada			
			Es responsabilidad del cuadrista.
10.9.4 Pruebas de armarios hechos de material aislante			
			Es responsabilidad del cuadrista.
10.10 Aumento de la temperatura			
			El cuadrista es responsable del cálculo del aumento de la temperatura. Eaton proporcionará datos de disipación de calor para los dispositivos.
10.11 Resistencia a los cortocircuitos			
			Es responsabilidad del cuadrista. Deben tenerse en cuenta las especificaciones de la aparamenta.
10.12 Compatibilidad electromagnética			
			Es responsabilidad del cuadrista. Deben tenerse en cuenta las especificaciones de la aparamenta.
10.13 Función mecánica			
			El dispositivo cumple los requisitos, siempre que se observe la información del folleto de instrucciones (IL).

Technical data ETIM 7.0

Conmutadores en baja tensión (EG000017) / Relé de sobrecarga térmica / magnetotérmico (EC000106)			
Tecnología electrónica, de automatización y de mando de procesos / Tecnología de conmutación de baja tensión / Unidad de protección contra sobrecargas / Relé de sobrecarga térmico (ecl@ss10.0.1-27-37-15-01 [AKF075014])			
Intervalo de intensidad ajustable		Ampere	10 - 16
Tensión de funcionamiento nominal máxima Ue		Volt	690
Método de montaje			Acoplamiento directo
Tipo de conexión del circuito de corriente principal			Conexión enroscada
Número de contactos auxiliares como contacto normalmente cerrado			1
Número de contactos auxiliares como contacto normalmente abierto			1
Número de contactos auxiliares como contacto de intercambio			0
Clase de liberación			EV011240

Approvals

Product Standards			IEC/EN 60947-4-1; UL 60947-4-1; CSA - C22.2 No. 60947-4-1-14; CE marking
UL File No.			E29184
UL Category Control No.			NKCR
CSA File No.			12528

CSA Class No.	3211-03
North America Certification	UL listed, CSA certified
Specially designed for North America	No
Suitable for	Branch circuits
Max. Voltage Rating	600 V AC
Degree of Protection	IEC: IP20, UL/CSA Type: -

Characteristics

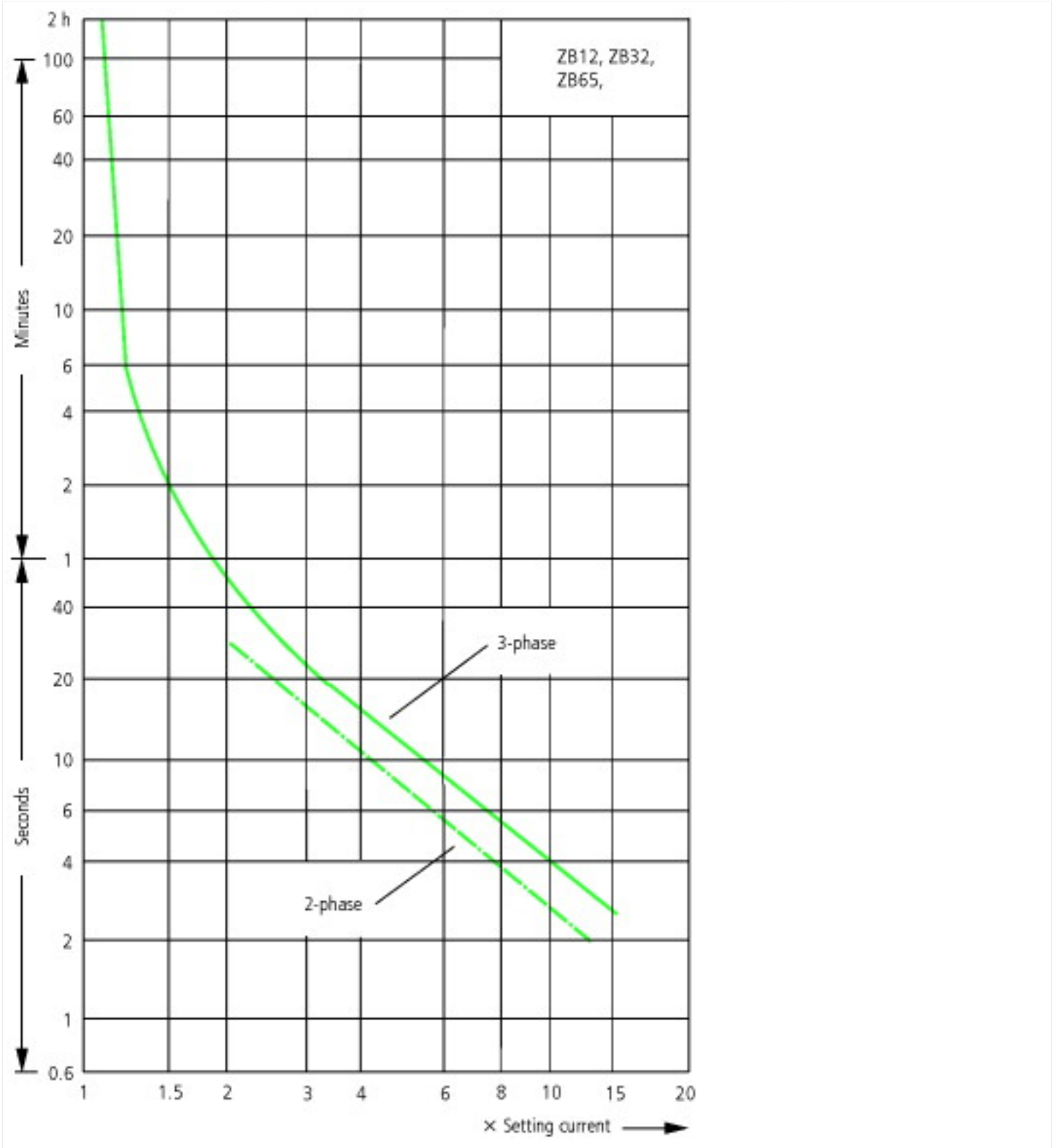

These tripping characteristics are mean values of the spreads at 20 °C ambient air temperature in a cold state. Tripping time depends on response current. When the devices are at operational temperature the tripping time of the overload relay falls to approx. 25 % of the read off value.

1: Minimum level, 3-phase
2: Maximum level, 3-phase
3: Minimum marker, 2-phase
4: Highest marker, 2-phase

Dimensions

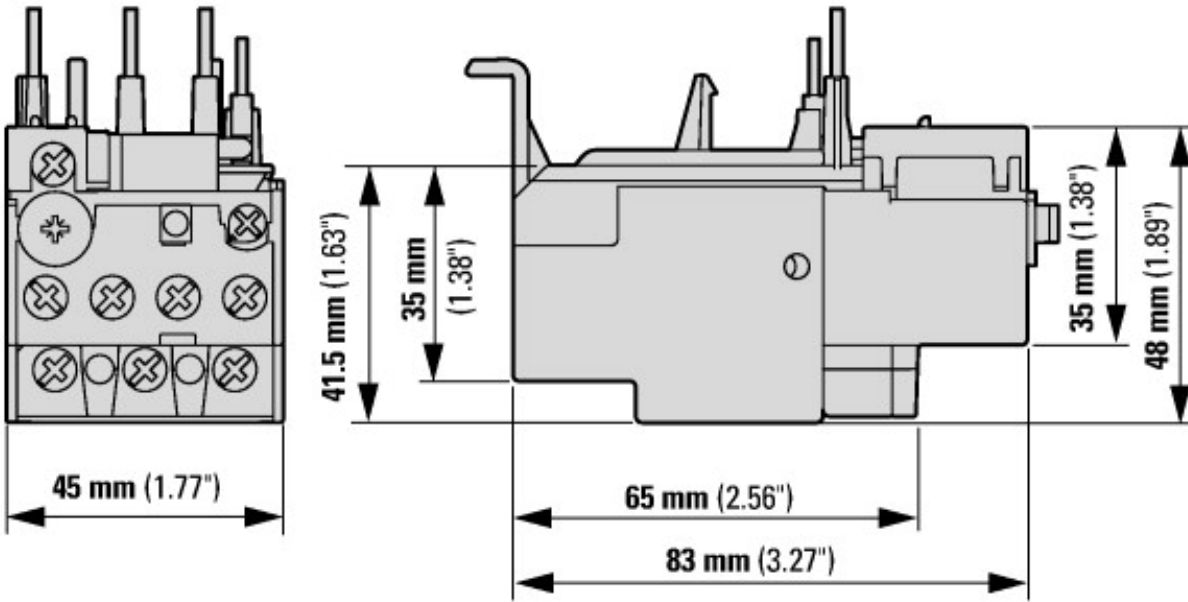

- ① OFF
- ② Reset/ON

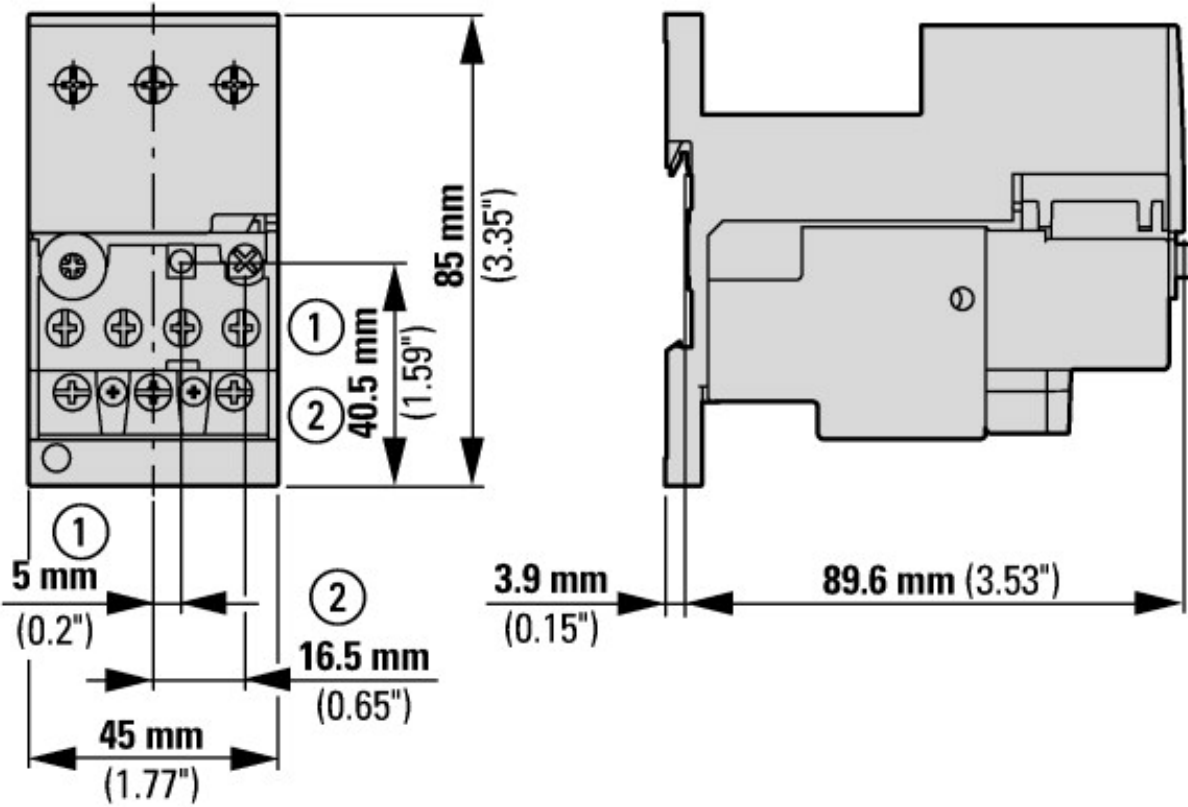

With base ZB32-XEZ



ZB32... + DILM

Additional product information (links)

IL03407015Z (AWA2300-2114) Overload relay

IL03407015Z (AWA2300-2114) Overload relay https://es-assets.eaton.com/DOCUMENTATION/AWA_INSTRUCTIONS/IL03407015Z2021_11.pdf

IL03407195Z Sealable shroud

IL03407195Z Sealable shroud https://es-assets.eaton.com/DOCUMENTATION/AWA_INSTRUCTIONS/IL03407195Z2021_10.pdf

MN03407004Z (AWB2300-1527D/GB) ZB12/XTOB...BC1 and ZB32/XTOB...CC1 overload relays, overload monitoring of Ex e motors

MN03407004Z (AWB2300-1527D/GB) ZB12/XTOB...BC1 and ZB32/XTOB...CC1 overload relays, overload monitoring of Ex e motors - Deutsch / English https://es-assets.eaton.com/DOCUMENTATION/AWB_MANUALS/MN03407004Z_DE_EN.pdf