

Switch Amplifier

KFD2-SR2-Ex2.W

- 2-channel isolated barrier
- 24 V DC supply (Power Rail)
- Dry contact or NAMUR inputs
- Relay contact output
- Line fault detection (LFD)
- Reversible mode of operation
- Up to SIL 2 acc. to IEC 61508/IEC 61511



Function

This isolated barrier is used for intrinsic safety applications. The device transfers digital signals from NAMUR sensors or dry contacts from the hazardous area to the non-hazardous area. The proximity sensor or the mechanical contact controls the control side load for a relay contact output. The device output changes the state when the input signal changes the state. Via switches the mode of operation can be reversed and the line fault detection can be switched off. During a fault condition, the relay reverts to its de-energized state and the LEDs indicate the fault according to NAMUR NE 44. If the device is operated via Power Rail, additionally a collective error message is available.

Connection

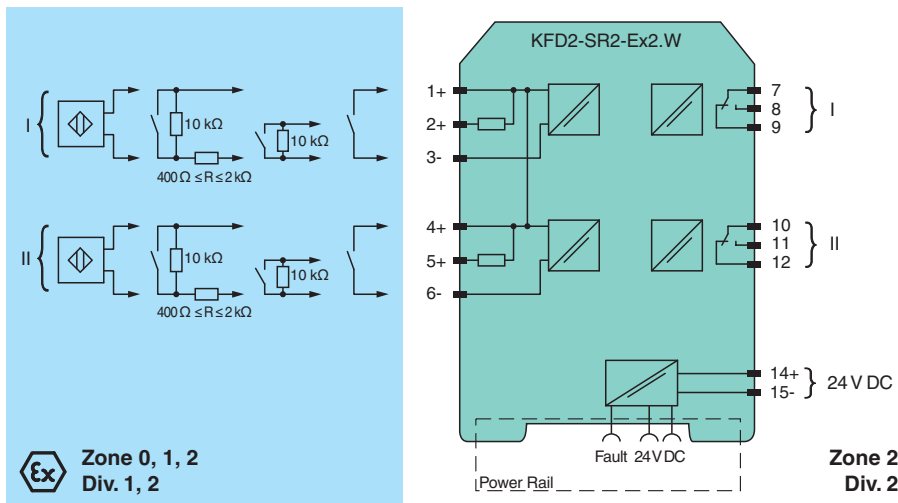

Technical Data

General specifications	
Signal type	Digital Input
Functional safety related parameters	
Safety Integrity Level (SIL)	SIL 2
Systematic capability (SC)	SC 3
Supply	
Connection	Power Rail or terminals 14+, 15-
Rated voltage	U_r 19 ... 30 V DC
Ripple	≤ 10 %
Rated current	I_r ≤ 50 mA

Release date: 2022-11-16 Date of issue: 2022-11-16 Filename: 203355_eng.pdf

Refer to "General Notes Relating to Pepperl+Fuchs Product Information".

Pepperl+Fuchs Group
www.pepperl-fuchs.com

USA: +1 330 486 0002
pa-info@us.pepperl-fuchs.com

Germany: +49 621 776 2222
pa-info@de.pepperl-fuchs.com

Singapore: +65 6779 9091
pa-info@sg.pepperl-fuchs.com

PEPPERL+FUCHS

Technical Data

Power dissipation	≤ 1 W
Power consumption	≤ 1 W
Input	
Connection side	field side
Connection	terminals 1+, 2+, 3-; 4+, 5+, 6-
Rated values	acc. to EN 60947-5-6 (NAMUR)
Open circuit voltage/short-circuit current	approx. 8 V DC / approx. 8 mA
Switching point/switching hysteresis	1.2 ... 2.1 mA / approx. 0.2 mA
Line fault detection	breakage I ≤ 0.1 mA , short-circuit I > 6 mA
Pulse/Pause ratio	min. 20 ms / min. 20 ms
Output	
Connection side	control side
Connection	output I: terminals 7, 8, 9 ; output II: terminals 10, 11, 12
Output I, II	signal, relay
Contact loading	250 V AC/2 A/cos φ > 0.75; 126.5 V AC/4 A/cos φ > 0.75; 40 V DC/2 A resistive load
Minimum switch current	2 mA / 24 V DC
Energized/De-energized delay	approx. 20 ms / approx. 20 ms
Mechanical life	10 ⁷ switching cycles
Collective error message	Power Rail
Transfer characteristics	
Switching frequency	≤ 10 Hz
Galvanic isolation	
Input/Output	reinforced insulation according to IEC/EN 61010-1, rated insulation voltage 300 V _{eff}
Input/power supply	reinforced insulation according to IEC/EN 61010-1, rated insulation voltage 300 V _{eff}
Output/power supply	reinforced insulation according to IEC/EN 61010-1, rated insulation voltage 300 V _{eff}
Output/Output	reinforced insulation according to IEC/EN 61010-1, rated insulation voltage 300 V _{eff}
Indicators/settings	
Display elements	LEDs
Control elements	DIP switch
Configuration	via DIP switches
Labeling	space for labeling at the front
Directive conformity	
Electromagnetic compatibility	
Directive 2014/30/EU	EN 61326-1:2013 (industrial locations)
Low voltage	
Directive 2014/35/EU	EN 61010-1:2010+A1:2019+A1:2019/AC:2019
Conformity	
Electromagnetic compatibility	NE 21:2017 , EN 61326-3-1:2017 , EN IEC 61326-3-2:2018
Degree of protection	IEC 60529:1989+A1:1999+A2:2013
Functional safety	IEC/EN 61508:2010
Input	EN 60947-5-6:2000
Ambient conditions	
Ambient temperature	-20 ... 70 °C (-4 ... 158 °F)
Mechanical specifications	
Degree of protection	IP20
Connection	screw terminals
Mass	approx. 150 g
Dimensions	20 x 119 x 115 mm (0.8 x 4.7 x 4.5 inch) (W x H x D) , housing type B2
Mounting	on 35 mm DIN mounting rail acc. to EN 60715:2001
Data for application in connection with hazardous areas	
EU-type examination certificate	PTB 00 ATEX 2080
Marking	Ⓢ II (1)G [Ex ia Ga] IIC Ⓢ II (1)D [Ex ia Da] IIIC Ⓢ I (M1) [Ex ia Ma] I

Release date: 2022-11-16 Date of issue: 2022-11-16 Filename: 203355_eng.pdf

Refer to "General Notes Relating to Pepperl+Fuchs Product Information".

Technical Data





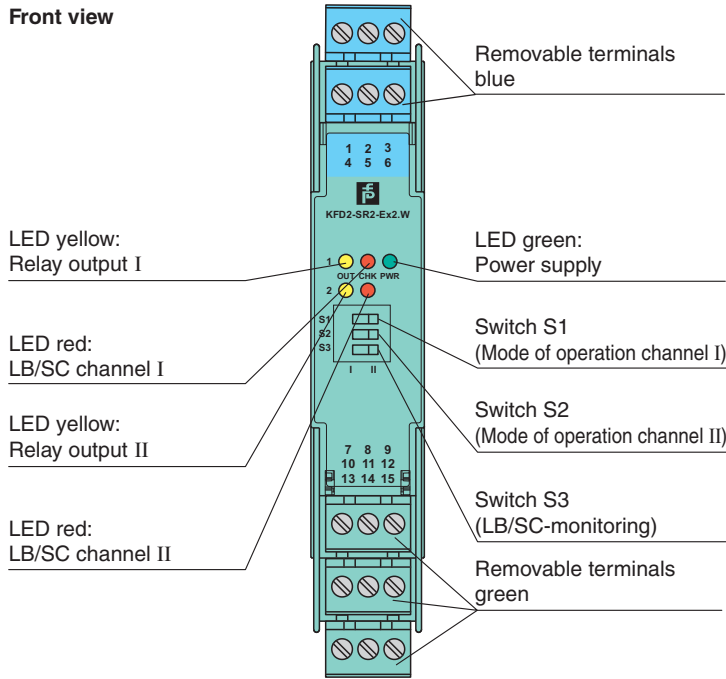

Input		Ex ia
Voltage	U _o	10.5 V
Current	I _o	13 mA
Power	P _o	34 mW (linear characteristic)
Supply		
Maximum safe voltage	U _m	253 V AC / 125 V DC (Attention! U _m is no rated voltage.)
Output		
Maximum safe voltage	U _m	253 V AC (Attention! The rated voltage can be lower.)
Fault indication output		
Maximum safe voltage	U _m	40 V DC (Attention! U _m is no rated voltage.)
Certificate		PF 08 CERT 0803
Marking		Ⓜ II (3)G [Ex ic Gc] IIC
Input		Ex ic
Voltage	U _o	10.5 V
Current	I _o	13 mA
Power	P _o	34 mW (linear characteristic)
Certificate		TÜV 99 ATEX 1493 X
Marking		Ⓜ II 3G Ex ec nC IIC T4 Gc
Galvanic isolation		
Input/Output		safe electrical isolation acc. to IEC/EN 60079-11, voltage peak value 375 V
Input/power supply		safe electrical isolation acc. to IEC/EN 60079-11, voltage peak value 375 V
Directive conformity		
Directive 2014/34/EU		EN IEC 60079-0:2018+AC:2020 , EN 60079-7:2015+A1:2018 , EN 60079-11:2012 , EN IEC 60079-15:2019
International approvals		
FM approval		
FM certificate		FM19US0207X
Control drawing		116-0035
UL approval		E106378
Control drawing		116-0473 (cULus)
Contact loading		250 V AC/2 A/cos φ > 0.75; 126.5 V AC/4 A/cos φ > 0.75; 30 V DC/2 A resistive load
IECEX approval		
IECEX certificate		IECEX PTB 11.0034 , IECEX TUN 19.0013X
IECEX marking		[Ex ia Ga] IIC [Ex ia Da] IIC [Ex ia Ma] I Ex ec nC IIC T4 Gc
General information		
Supplementary information		Observe the certificates, declarations of conformity, instruction manuals, and manuals where applicable. For information see www.pepperl-fuchs.com .

Assembly





Front view



Matching System Components

	KFD2-EB2	Power Feed Module
	UPR-03	Universal Power Rail with end caps and cover, 3 conductors, length: 2 m
	UPR-03-M	Universal Power Rail with end caps and cover, 3 conductors, length: 1,6 m
	UPR-03-S	Universal Power Rail with end caps and cover, 3 conductors, length: 0.8 m
	K-DUCT-BU	Profile rail, wiring comb field side, blue
	K-DUCT-BU-UPR-03	Profile rail with UPR-03- * insert, 3 conductors, wiring comb field side, blue

Accessories

	F-NR3-Ex1	NAMUR Resistor Network
	KF-ST-5GN	Terminal block for KF modules, 3-pin screw terminal, green
	KF-ST-5BU	Terminal block for KF modules, 3-pin screw terminal, blue
	KF-CP	Red coding pins, packaging unit: 20 x 6

Release date: 2022-11-16 Date of issue: 2022-11-16 Filename: 203355_eng.pdf

Refer to "General Notes Relating to Pepperl+Fuchs Product Information".

Configuration

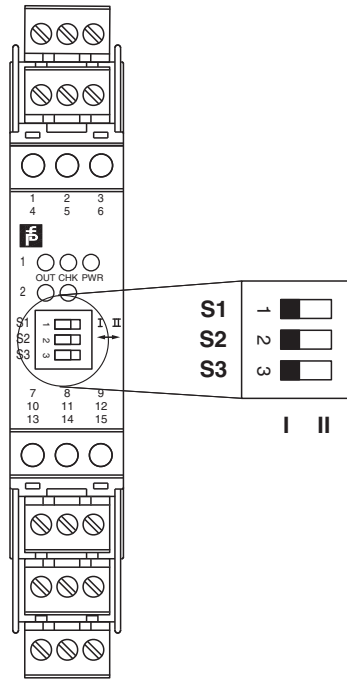

Switch position

S	Function		Position
1	Mode of operation output I (relay) energized	with high input current	I
		with low input current	II
2	Mode of operation output II (relay) energized	with high input current	I
		with low input current	II
3	Line fault detection	ON	I
		OFF	II

Operating states

Control circuit	Input signal
Initiator high impedance/contact opened	low input current
Initiator low impedance/contact closed	high input current
Lead breakage, lead short circuit	Line fault

Factory setting: switch 1, 2 and 3 in position I

Characteristic Curve

Maximum switching power of output contacts

Release date: 2022-11-16 Date of issue: 2022-11-16 Filename: 203355_eng.pdf

Refer to "General Notes Relating to Pepperl+Fuchs Product Information".

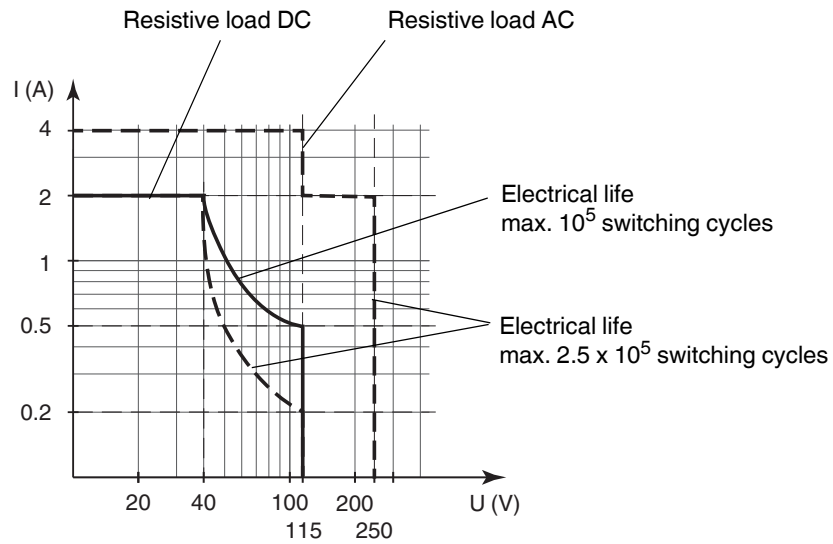

The maximum number of switching cycles is depending on the electrical load and may be higher when reduced currents and voltages are applied.